

2023

Comfortex
WINDOW FASHIONS

Distributed by:

MDS Midwest
Designer
Supply
WINDOW FASHIONS

1-888-523-2611



PRELUDE CELLULAR SHADES

Manufacturer's Price List and Reference Guide

Effective April 17, 2023 | Updated 03/30/2023



Detailed Table of Contents



Hardware



Photos



Price Grids



Videos



Product Specifications



Installation



General Information



Web



 Requires you to leave document

Prelude Cellular Shades Price List - Effective 04.17.2023

Version 1	Original Price List Effective April 17, 2023	Uploaded 03/17/2023
Version 2	Surcharge removed for 2-on-1 and 3-on-1 shades. Pg 15 Surcharge updated Cordless Ultra Bottom-Up	Uploaded 03/30/2023



Hardware Options









Size Standards

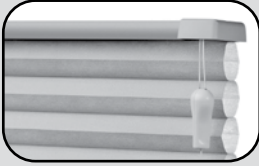

Hardware Options Pricing

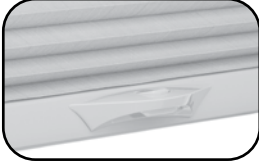
Prelude Shade Collection



HARDWARE OPTIONS

	Key Features	Color Options	Hardware Size (Depth x Height)	Widths & Lengths*	More Information
Cord Lock 	<ul style="list-style-type: none"> Reliable cord lock Sleek, color coordinated rails UV resistant materials 	<ul style="list-style-type: none"> Color Coordinated Fabric Wrapped Oil Rubbed Bronze 	Standard Head Rail: 1 $\frac{7}{8}$ " x $\frac{1}{2}$ " Deluxe Head Rail: 2 $\frac{3}{8}$ " x $\frac{1}{2}$ "	Width: 8" up to 144" Length: 8" up to 120"	Page 24
Cord Loop 	<ul style="list-style-type: none"> Great for large windows Smooth & quiet operation 	<ul style="list-style-type: none"> Color Coordinated Fabric Wrapped Oil Rubbed Bronze 	2 $\frac{1}{4}$ " x 1 $\frac{1}{2}$ "	Width: 14" up to 144" Length: 8" up to 120"	Page 26
Cordless Ultra 	<ul style="list-style-type: none"> Child safe No visible cords Smooth & quiet operation Sleek clear handle on rails Two-On-One option available 	<ul style="list-style-type: none"> Color Coordinated Fabric Wrapped Oil Rubbed Bronze 	2 $\frac{1}{4}$ " x 1 $\frac{1}{2}$ "	Width: 18" up to 144" Length: 8" up to 84"	Page 28
Cordless Lift & Lock 	<ul style="list-style-type: none"> Child safe Easy push button operation Rails lock securely in place in any position Color coordinated rails and handle 	<ul style="list-style-type: none"> Color Coordinated Fabric Wrapped Oil Rubbed Bronze 	Standard Head Rail: 1 $\frac{7}{8}$ " x $\frac{1}{2}$ " Deluxe Head Rail: 2 $\frac{3}{8}$ " x $\frac{1}{2}$ " Bottom Rail: 1 $\frac{7}{8}$ " x 1 $\frac{1}{8}$ "	Width: 16" up to 96" Length: 8" up to 84"	Page 30
7.4V Rechargeable Simplicity Motorization 	<ul style="list-style-type: none"> Raise & lower shade with click of a button Great for large and hard to reach windows Remote can operate multiple shades Standard or Top Down-Bottom Up 	<ul style="list-style-type: none"> Color Coordinated Fabric Wrapped Oil Rubbed Bronze 	2 $\frac{1}{4}$ " x 1 $\frac{1}{2}$ "	Width: 18" up to 108" Length: 8" up to 120"	Page 32
7.4V Rechargeable PowerTouch™ Cordless Wand 	<ul style="list-style-type: none"> Raise & lower shade with push of a button Just "Touch & Go" to operate the shade Set your favorite shade position Easy access to charging port on side of pendant 	<ul style="list-style-type: none"> Wand and pendant available in white or black 	2 $\frac{1}{4}$ " x 1 $\frac{1}{2}$ "	Width: 18" up to 144" Length: 8" up to 120"	Page 37
Ovation™ Slider 	<ul style="list-style-type: none"> Vertically oriented fabric glides across window Shade can stack left, right or center Great for sliding glass doors or room dividers 	<ul style="list-style-type: none"> White (Standard) Ivory Beige Tan Gray 	3 $\frac{5}{8}$ " x 1 $\frac{3}{4}$ "	Width: 12" up to 168" Length: 24" up to 120"	Page 41

* Maximum widths and lengths listed do not take into account square foot or weight limitations. Make sure to refer to shaded areas on price groups for maximum size availability by fabric style.

Prelude Shade Collection

HARDWARE OPTIONS

	Key Features	Color Options	Hardware Size (Depth x Height)	Widths & Lengths*	More Information
Top Down-Bottom Up 	<ul style="list-style-type: none"> • Lower shade from top: raise from bottom • Great for privacy • Ideal for light control • Available in Cord Lock, Cord Loop, Cordless and motorized 	<ul style="list-style-type: none"> • Color Coordinated • Fabric Wrapped • Oil Rubbed Bronze 	Dependent on hardware choice	Width: 18" up to 120" Length: 8" up to 120"	See Product Availability Page 9
Two on One Head Rail 	<ul style="list-style-type: none"> • Operate two shades on one rail • Great for larger windows • Individually operating shades 	<ul style="list-style-type: none"> • Color Coordinated • Fabric Wrapped • Oil Rubbed Bronze 	Dependent on Style See Above	Width: 16" up to 144" Length: 8" up to 120"	See Product Availability Page 9

Maximum widths and lengths listed do not take into account square foot or weight limitations. Make sure to refer to shaded areas on price groups for maximum size availability by fabric style. Make sure to consult specification charts for specific fabric styles.

Cellular Shade Collection

FABRIC COLLECTIONS

Fabric Collection	Cell Size and Structure	Opacities	Fabric Content
Prelude	<ul style="list-style-type: none"> • ¾-Inch • 1 ½-Inch • 2 -Inch • Single Cell 	<ul style="list-style-type: none"> • Light Filtering • Blackout 	<ul style="list-style-type: none"> • Light Filtering: Non-Woven Polyester • Blackout: Non-Woven Polyester with foil lining

Prelude Shade Collection

SIZE STANDARDS

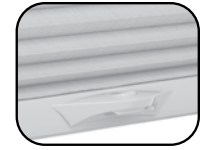
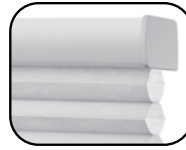
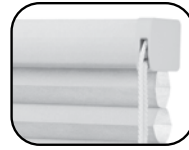
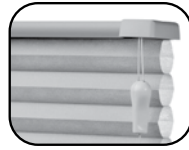

		Cord Lock		Cord Loop		Cordless Ultra		Cordless Lift & Lock		
Minimum		Bottom Up	Top Down Bottom Up	Bottom Up	Top Down Bottom Up	Bottom Up	Top Down Bottom Up	Bottom Up	Top Down Bottom Up	
Prelude 3/4"	Min. Width	8"	10"	18"	24"	16"	16"	10" OB or 10 3/8" IB	16" OB or 16 3/8" IB	
	Min. Length	12"	12"	12"	12"	12"	12"	12"	12"	
Prelude 1 1/4"	Min. Width	Not Available		Not Available		16"	18"	Not Available		
	Min. Length	Not Available		Not Available		12"	12"	Not Available		
Prelude 2"	Min. Width	Not Available		18"	24"	16"	16"	10" OB or 10 3/8" IB	16" OB or 16 3/8" IB	
	Min. Length	Not Available		12"	12"	12"	12"	12"	12"	
Light Filtering			Bottom Up	Top Down Bottom Up	Bottom Up	Top Down Bottom Up	Bottom Up	Top Down Bottom Up	Bottom Up	Top Down Bottom Up
Prelude 3/4"	Price Group 1	Page 13	Maximum Width & Length - Sq Ft. 72" width 120" length 50 sq ft	60" width 96" length 50 sq ft	120" width 120" length 100 sq ft	120" width 120" length 100 sq ft	120" width 84" length 70 sq ft	96" width 84" length 56 sq ft	84" width 84" length 49 sq ft	84" width 84" length 49 sq ft
Prelude 1 1/4"	3	15	Maximum Width & Length - Sq Ft.	Not Available	Not Available	120" width 84" length 60 sq ft	96" width 84" length 56 sq ft	Not Available		
Prelude 2"	5	16	Maximum Width & Length - Sq Ft.	Not Available	120" width 120" length 60 sq ft	120" width 120" length 60 sq ft	120" width 84" length 60 sq ft	120" width 84" length 60 sq ft	84" width 84" length 49 sq ft	84" width 84" length 49 sq ft
Room Darkening & Blackout			Bottom Up	Top Down Bottom Up	Bottom Up	Top Down Bottom Up	Bottom Up	Top Down Bottom Up	Bottom Up	Top Down Bottom Up
Prelude 3/4"	Price Group 2	Page 14	Maximum Width & Length - Sq Ft. 72" width 120" length 50 sq ft	60" width 96" length 50 sq ft	120" width 120" length 100 sq ft	120" width 120" length 100 sq ft	96" width 84" length 56 sq ft	96" width 84" length 56 sq ft	84" width 84" length 49 sq ft	84" width 84" length 49 sq ft
Prelude 1 1/4"	4	15	Maximum Width & Length - Sq Ft.	Not Available	Not Available	120" width 84" length 60 sq ft	96" width 84" length 56 sq ft	Not Available		
Prelude 2"	6	17	Maximum Width & Length - Sq Ft.	Not Available	120" width 120" length 60 sq ft	120" width 120" length 60 sq ft	120" width 84" length 60 sq ft	120" width 84" length 60 sq ft	84" width 84" length 49 sq ft	84" width 84" length 49 sq ft
			Bottom Up	Top Down Bottom Up	Bottom Up	Top Down Bottom Up	Bottom Up	Top Down Bottom Up	Bottom Up	Top Down Bottom Up
Stacking Heights Information On Page More Information On Page			Page 10 Page 24		Page 10 Page 26		Page 10 Page 28		Page 10 Page 30	

NOTE: Cordlock: Please Note: For any shades under 12" width, the maximum height is 80".
 Cordloop and cordless shades less than 24" in width are limited to 84" in length
 Maximum width for side mount refer to hardware pages.

Prelude Shade Collection

SIZE STANDARDS



		Minimum		Motorization		Motorization		Two-On-One Head Rail	
				Simplicity	Simplicity+ Rechargeable	PowerTouch Rechargeable	Cord Lock	Cord Loop/Cordless	
Prelude ¾"	Min. Width			18"		18"	8"	36"	
	Min. Length			12"		12"	12"	12"	
Prelude 1¼"	Min. Width			Not Available		24"	Not Available	NA / 16" Panel NA / 32" Overall	
	Min. Length						12"	Not Available	NA / 12"
Prelude 2"	Min. Width			18"		Not Available	Not Available	18" / 16" Panel 36" / 32" Overall	
	Min. Length			12"			Not Available	12" / 12"	

Light Filtering			Price Group	Page	Motorization		Two-On-One Head Rail		
					Simplicity	Simplicity Rechargeable	PowerTouch Rechargeable	Cord Lock	Cord Loop/Cordless
Prelude ¾"	1	13	Maximum Width & Length - Sq Ft.		96" width 96" length** 50 sq ft		96" width 96" length** 50 sq ft	144" width 120" length 50 sq ft	120" width 120" length++ 50 sq ft
Prelude 1¼"	3	15	Maximum Width & Length - Sq Ft.		Not Available		96" width 96" length 40 sq ft	Not Available	NA / 96" Panel NA / 120" Overall NA / 84" Length NA / 60 sq ft
Prelude 2"	5	16	Maximum Width & Length - Sq Ft.		96" width 96" length		Not Available	Not Available	102" / 100" Panel 120" / 120" Overall 120" / 84" Length 60 sq ft

Room Darkening & Blackout			Price Group	Page	Motorization		Two-On-One Head Rail		
					Simplicity	Simplicity Rechargeable	PowerTouch Rechargeable	Cord Lock	Cord Loop/Cordless
Prelude ¾"	2	14	Maximum Width & Length - Sq Ft.		96" width 96" length** 50 sq ft		96" width 96" length** 50 sq ft	144" width 120" length 40sq ft	120" width 120" length++ 50 sq ft
Prelude 1¼"	4	15	Maximum Width & Length - Sq Ft.		Not Available		96" width 96" length 45 sq ft	Not Available	NA / 96" Panel NA / 120" Overall NA / 84" Length NA / 60 sq ft
Prelude 2"	6	17	Maximum Width & Length - Sq Ft.		96" width 96" length		Not Available	Not Available	102" / 100" Panel 120" / 120" Overall 120" / 84" Length 60 sq ft

		Simplicity	Simplicity Rechargeable	PowerTouch Rechargeable	Cord Lock	Cord Loop/Cordless
Stacking Heights Information On Page More Information On Page		Page 10 Page 32		Page 10 Page 37		Page 10 Page 24-31

* Maximum widths and lengths listed do not take into account square foot or weight limitations. Make sure to refer to shaded areas on price groups for maximum size availability by fabric style. **Motorized shades less than 24" in width are limited to a maximum of 60" in length. +Simplicity Rechargeable Top Down-Bottom Up motorization minimum width is 24" IB and 23½" OB. ++ Cordloop is 120", Cordless is 84" maximum length

Prelude Ovation Cellular Slider Shade

SIZE STANDARDS



Ovation Cellular Slider	
Standard	
Minimum Width	12"
Minimum Length	24"

Light Filtering	Price Group	Page	Maximum Width & Length	Ovation Cellular Slider
Prelude 3/4" & 2"	7	18	Maximum Width & Length	168***" x 120"

Room Darkening & Blackout	Price Group	Page	Maximum Width & Length	Ovation Cellular Slider
Prelude 3/4" & 2"	8	18	Maximum Width & Length	168***" x 120"

Maximum Square Footage Side=100"
 Split=140"

Ovation Cellular Slider	
More Information On Page	Page 41

- * Split stack sliders are available in widths up to 240"; however, if the width exceeds 120", it will be fabricated as two separate sliders. The supplied valance will create the appearance of a single slider.
- ** Split stack sliders are available to 336", however if the width exceeds 168", the shade will be fabricated as two separate sliders. Supplied valance will create the appearance of a single slider. Please call customer service for assistance.
- *** Prelude split stack can go up to 190" wide on one head rail.

Prelude Speciality Shaped Shades

SIZE STANDARDS

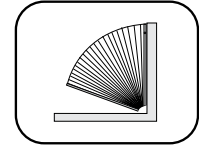
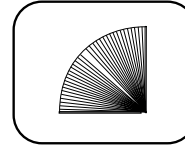
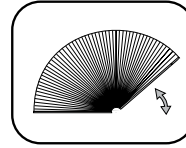
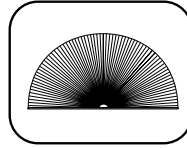

		Starburst Non-Movable Arch	Starburst Movable Arch	Quarter Round Non-Movable	Quarter Round Movable
Prelude ¾"	Minimum Width	12"	12"	12"	12"
	Minimum Length	12"	12"	12"	12"

Light Filtering	Price Group	Page		Starburst Non-Movable Arch	Starburst Movable Arch	Quarter Round Non-Movable	Quarter Round Movable
Prelude ¾"	9	19	Max Width & Length	84" x 42"	84" x 42"	42" x 42"	42" x 42"

Room Darkening & Blackout	Price Group	Page #		Starburst Non-Movable Arch	Starburst Movable Arch	Quarter Round Non-Movable	Quarter Round Movable
Prelude ¾"	10	19	Max Width & Length	60" x 30"	60" x 30"	42" x 42"	NA

	Starburst Non-Movable Arch	Starburst Movable Arch	Quarter Round Non-Movable	Quarter Round Movable
More Information On Page	Page 43	Page 43	Page 46	Page 46

NOTE: Starburst Movable Arches are available as inside mount only.
 Through our maximum width is 84" and our maximum is 72" on Sunset Arches, there are limitations on some larger sizes due to excessive weight.
 If the Sunset width exceeds 66", the maximum length is 60". If the Sunset width exceeds 72", the maximum length is 48".

Prelude Speciality Shaped Shades

SIZE STANDARDS

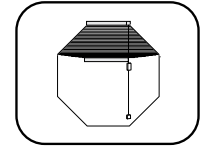
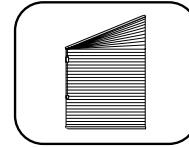
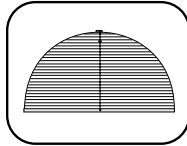

		Sunset Arch	Trapezoid	Octagon
Prelude 3/4"	Minimum Width	18"	12"	NA
	Minimum Length	6"	12"	NA

Light Filtering	Price Group	Page		Sunset Arch	Price Group	Page	Trapezoid	Octagon
Prelude 3/4"	11	20	Max Width & Length	84" x 48"	13	21	48" x 84"	NA

Room Darkening & Blackout	Price Group	Page		Sunset Arch	Price Group	Page	Trapezoid	Octagon
Prelude 3/4"	12	20	Max Width & Length	60" x 48"	13	21	48" x 72"	NA

	Sunset Arch	Trapezoid	Octagon
More Information On Page	Page 45	Page 47	Page 47

NOTE: Through our maximum width is 84" and our maximum is 72" on Sunset Arches, there are limitations on some larger sizes due to excessive weight. If the Sunset width exceeds 66", the maximum length is 60". If the Sunset width exceeds 72", the maximum length is 48".

Prelude Skylight and Greenhouse Shades

SIZE STANDARDS

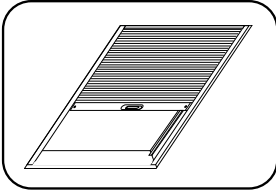

		Minimum	Balcony* 0°-15° 15°-75° 75°-90°**
Prelude 3/4"	Min Width		18"
	Min Length		12"

				Balcony* 0°-15°	15°-75°	75°-90°**
Light Filtering	Price Group Page					
Prelude 3/4"	Grid 15	Pg 22	Max Width & Length	60" x 72" 25 sq ft		

				Balcony* 0°-15°	15°-75°	75°-90°**
Room Darkening & Blackout						
Prelude 3/4"	Grid 15	Pg 22	Max Width & Length	60" x 72" 25 sq ft		

More Information On Page	Page 49
--------------------------	---------

*Total Balcony shade area not to exceed 24 square feet. **Total Balcony shade area not to exceed 18 square feet. Balcony shades can be mounted on their side. Use vertical measurement as your width (max 36") and the horizontal measurement as your length (max 48"). ***Soprano Skylight minimum installation angle of 5 degrees. Maximum installation angle of 85 degrees. Horizontal (0 degrees) and vertical (90 degrees) applications are not recommended. +All Soprano Greenhouse shade orders require a completed and signed greenhouse shade order form. Orders must be faxed to Comfortex for processing. Download a copy of the order form at www.comfortex.com/comfortex-dealers.

Soprano Greenhouse shades are available in 3/8" Symphony light filtering and Debut 1/2" light filtering only.

Prelude Cellular Shade Collection

HARDWARE OPTION AVAILABILITY

Use this table to ensure your coordinating options and unique shapes are consistent with your product selections.

STANDARD CORD LOCK	Prelude 3/4" LF & RD	Prelude 1 1/4" LF & RD	Prelude 2" LF & RD
Standard Cord Lock	•	-	-
Top Down-Bottom Up	•	-	-
Two-On-One Head Rail	•	-	-
CORD LOOP			
Cord Loop	•	-	•
Cord Loop Top Down-Bottom Up	•	-	•
Cord Loop Two-On-One Head Rail	•	-	•
CORDLESS ULTRA			
Cordless Ultra	•	•	•
Cordless Two-On-One Head Rail	•	•	•
Cordless Ultra Top Down-Bottom Up	•	•	•
CORDLESS LIFT & LOCK			
Cordless Lift & Lock	•	-	•
Cordless Lift & Lock Two-On-One Head Rail	•	-	•
Cordless Lift & Lock Top Down-Bottom Up	•	-	•
MOTORIZATION			
Simplicity Motorization	-	-	-
Simplicity Rechargeable Motorization	•	-	•
PowerTouch™ Rechargeable	•	•	-
12v PowerTouch™ Non-Rechargeable	-	-	-
Top Down-Bottom Up	•	-	•
SKYLIGHTS AND SPECIALTY SHAPES			
Balcony Shading System	•	-	-
French Door Decor	-	-	-
Mezzo Motorized Skylights	-	-	-
Octagon	-	-	-
Ovation Cellular Slider	•	-	•
Quarter Round - Moveable	-	-	-
Quarter Round - Non-Movable	•	-	-
Soprano Skylights	-	-	-
Soprano Greenhouses	-	-	-
Starburst Arch - Movable	•	-	-
Starburst Arch - Non-Movable	•	-	-
Sunset Arch - Moveable	•	-	-
Trapezoid	•	-	-

++ 3/4" Premiere fabrics only

Prelude Shade Collection

SHADE STACK HEIGHTS

Measurements are in inches. Shade stacking heights applicable when the shade is in the fully raised position.

RECTANGULAR CORD LOCK - Includes head and bottom rails	48"	72"	84"	96"	108"	120"
Prelude Light Filtering	2"	2 ³ / ₈ "	2 ⁵ / ₈ "	2 ⁷ / ₈ "	3 ¹ / ₈ "	3 ³ / ₈ "
Prelude Blackout	1 ¹ / ₂ "	1 ³ / ₄ "	1 ⁷ / ₈ "	2"	2 ¹ / ₈ "	2 ¹ / ₄ "

For Top Down-Bottom Up, add ⁵/₈"

CORD LOOP - CORDLESS ULTRA - MOTORIZATION - Includes head and bottom rails	48"	72"	84"	96"	108"	120"
Prelude Light Filtering	3"	3 ³ / ₈ "	3 ⁵ / ₈ "	3 ⁷ / ₈ "	4 ¹ / ₈ "	4 ³ / ₈ "
Prelude Blackout	2 ¹ / ₄ "	2 ¹ / ₂ "	2 ⁵ / ₈ "	2 ³ / ₄ "	2 ⁷ / ₈ "	3

For Top Down-Bottom Up, add ⁵/₈"

CORDLESS LIFT & LOCK - Includes head and bottom rails	48"	60"	72"	84"	108"	120"
Prelude Light Filtering	2 ³ / ₄ "	3 ¹ / ₈ "	3 ³ / ₈ "	3 ⁵ / ₈ "	3 ⁷ / ₈ "	4 ¹ / ₈ "
Prelude Blackout	2 ¹ / ₄ "	2 ¹ / ₂ "	2 ⁵ / ₈ "	2 ³ / ₄ "	2 ⁷ / ₈ "	3

For Top Down-Bottom Up, add 1¹/₄"

OVATION	84"	96"	108"	120"
Prelude	6 ¹ / ₂ "	7 ¹ / ₄ "	8"	8 ³ / ₄ "

Ovations minimum fabric stack measures 6¹/₂" regardless of the ordered width. Fabric stacking dimensions are determined by the slider's hardware, not ordered width.

Prelude Shade Pricing Examples

Rechargeable Simplicity Pricing Example:

Prelude	
Light Filtering 42" x 60" Shade:	\$333.00
Simplicity Rechargeable Motor Surcharge:	\$300.00
Charger for Rechargeable:	\$30.00
14 Channel Remote Control:	\$50.00
Total List Price:	\$713.00

Motorized Top Down-Bottom Up Pricing Example:

Prelude	
Light Filtering 42" x 60" Shade:	\$333.00
Simplicity Rechargeable TDBU Surcharge:	\$515.00
Charger for Rechargeable:	\$30.00
TDBU Remote Control:	\$50.00
Total List Price:	\$928.00

Cordless Ultra Simplicity Pricing Example:

Prelude	
Light Filtering 42" x 60" Shade:	\$333.00
Cordless Ultra Surcharge:	\$108.00
Total List Price:	\$441.00

Simplicity Motorization Pricing Example:

Prelude	
Light Filtering 42" x 60" Shade:	\$333.00
Simplicity Motor Surcharge:	\$300.00
14 Channel Remote Control:	\$50.00
Total List Price:	\$683.00

Prelude Shade Collection

HARDWARE UPGRADE OPTIONS

LIFT SYSTEM	UPGRADES	ADD	DESIGNER UPGRADE OPTIONS	UPGRADES	ADD
Cord Lock	Top Down-Bottom Up	\$85	Add to Any Lift System Upgrade (Chart to the left)	Metallic Hardware	\$30
	Cordless Lift & Lock	Bottom Up			
	Top Down-Bottom Up	\$108		Fabric Wrapped Hardware	\$48
Cordless Ultra	Bottom Up	\$108			
	Top Down-Bottom Up	\$215			
Cord Loop	Bottom Up	\$108			
	Top Down-Bottom Up	\$215			
ADDITIONAL OPTIONS	UPGRADES	ADD			
Add to Any Upgrade Above	Two-On-One Head Rail	Price each panel as a separate shade, including lift system upgrades, add together.			
	Three-On-One Head Rail	Price each panel as a separate shade, including lift system upgrades, add together.			
	Cut Outs <i>Available on Cordlock & Cordloop See page 53 for more information</i>	\$69 Per side			
	Day-Night	Price each separate shade then add together			
Other	Ovation Center Stack	\$108			

Cellular Shade **Motorized** Hardware Upgrade Options

MOTORIZED	UPGRADES	ADD	
7.4V PowerTouch Rechargeable Motorization System	Rechargeable Integrated Battery Pack	\$100	For More Information Page 37
	Plug-In Charger for Rechargeable Li-Ion	\$30	
7.4V Simplicity Rechargeable Motorization System	Motor and Integrated Battery Pack	\$300	For More Information Page 32
	Plug-In Charger for Rechargeable Li-Ion	\$30	
	Top Down-Bottom Up*	\$515	
	7.4v Solar Panel & Mounting Brackets	\$120	
Simplicity Systems Controllers	NEO Controller	\$280	For More Information Pages 52, 34 & 36
	NEO App for Mobile Devices	FREE	
	Simplicity 14 Channel White Remote **	\$50	

*Upcharge includes motorization plus second motor and Top Down-Bottom Up components
 ** Simplicity 14 channel remote is TDBU capable and is required for Motorized Top Down-Bottom Up shades



1 Cord Lock | Cordless Lift & Lock
Prelude 3/4" Light Filtering



9 Starburst Arches | Quarter Rounds
Prelude 3/4" Light Filtering



2 Cord Lock | Cordless Lift & Lock
Prelude 3/4" Blackout



10 Starburst Arches | Quarter Rounds
Prelude 3/4" Blackout



3 Base Grid (Must add lift control options)
Prelude 1 1/4" Light Filtering



11 Sunset Movable Arches
Prelude 3/4" Light Filtering



4 Base Grid (Must add lift control options)
Prelude 1 1/4" Blackout



12 Sunset Movable Arches
Prelude 3/4" Blackout



5 Cordless Lift & Lock
Prelude 2" Light Filtering



13 Trapezoids | Octagons
Prelude 3/4" Light Filtering



6 Cordless Lift & Lock
Prelude 2" Blackout



14 Trapezoids
Prelude 3/4" Blackout



7 Ovation Cellular Slider
Prelude 3/4" Light Filtering
Prelude 2" Light Filtering



15 Skylight Shading System
Prelude 3/4" Light Filtering



8 Ovation Cellular Slider
Prelude 3/4" Blackout
Prelude 2" Blackout



16 Skylight Shading System
Prelude 3/4" Blackout

Prelude Shade Collection

PRICING

Prelude 3/4" Light Filtering

PRICE GROUP 1

Cord Lock

Cordless Lift & Lock

		Width In Inches												
		24	30	36	42	48	54	60	66	72	84	96	108	120
Length In Inches	36	165	182	210	234	257	280	304	325	351	399	450	499	551
	42	177	202	224	254	280	305	333	357	385	442	496	553	613
	48	186	216	246	274	304	332	360	392	420	490	559	630	701
	54	201	227	260	293	327	357	398	434	475	553	630	709	786
	60	212	244	280	315	348	398	438	482	526	613	700	786	874
	66	221	257	298	339	387	434	482	530	579	675	770	866	963
	72	234	269	315	369	422	475	526	579	630	735	839	944	1047
	78	246	289	342	399	456	512	571	627	683	795	908	1022	1135
	84	253	308	369	431	490	553	613	675	735	856	978	1100	1222
	90	264	330	398	461	526	592	657	720	786	918	1047	1177	1308
	96	281	352	422	490	559	630	700	770	839	978	1118	1255	1396
	108	316	398	475	553	630	709	786	866	944	1100	1255	1414	1568
120	352	438	526	613	700	786	874	961	1047	1222	1395	1568	1742	

■ Cord Loop Hardware is recommended on sizes within the shaded area.
 Motorized lift systems are not offered within the shaded area.

LIFT SYSTEM AND DESIGN UPGRADES			ADD
Cord Lock	Top Down-Bottom Up		\$85
Cordless Lift & Lock	Bottom Up		No Charge
	Top Down-Bottom Up		\$108
Cordless Ultra	Bottom Up		\$108
	Top Down-Bottom Up		\$215
Cord Loop	Bottom Up		\$108
	Top Down-Bottom Up		\$215
DESIGNER UPGRADE OPTIONS (Add to any Lift System Upgrade Above - Not available on Cord Lock)			ADD
Metallic Hardware (Not available on Lift & Lock or Cord Lock)			\$30
Fabric Wrapped Hardware (Not available on Cord Lock)			\$48
MOTORIZATION*			MORE INFO
7.4V PowerTouch Rechargeable			Pg 37 \$100
7.4V Simplicity Rechargeable Motorization - Motor with Integrated Battery			Pg 32 \$300
Plug-In Charger for Li-Ion Battery Pack (used for PowerTouch and Simplicity Rechargeable and is required)			Pg 34 \$30
Simplicity 14 Channel White Remote			Pg 36 \$50
Simplicity Smart Controller (NEO)			Pg 40 \$280
Top Down-Bottom Up Motorization and Solar Charge Option Pricing			Pg 11
7.4V EZ Charge Extension Wand	Wall Mount Receiver Kit 7.4V	\$18	For More Information Page 39
	Extendable Wand 7.4V	\$32	
ADDITIONAL OPTIONS		MORE INFO	
Two-On-One/Three-On-One Head Rail		Price each panel as a separate shade, including lift system upgrades, add together.	
For additional options and surcharges refer to page 11.		Pg 11	

*Motorized Pricing Examples pages 81, 128, 130 and 133

Prelude Shade Collection

PRICING

Prelude 3/4" Blackout

PRICE GROUP 2

Cord Lock

Cordless Lift & Lock

		Width In Inches												
		24	30	36	42	48	54	60	66	72	84	96	108	120
Length In Inches	36	222	246	284	316	347	378	411	438	472	539	607	673	744
	42	238	270	303	341	378	411	450	482	520	597	671	747	827
	48	252	291	332	369	411	449	487	529	568	661	755	851	946
	54	269	308	351	393	439	482	535	585	639	747	851	958	1062
	60	285	331	378	426	470	535	592	648	709	827	945	1062	1177
	66	299	347	403	458	522	585	648	716	780	912	1040	1168	1298
	72	316	363	426	499	569	639	709	780	851	993	1134	1273	1415
	78	332	388	463	539	615	691	771	846	922	1073	1227	1380	1532
	84	340	415	499	582	661	747	827	912	993	1156	1320	1485	1650
	90	357	446	535	622	709	798	886	973	1062	1238	1415	1588	1766
	96	380	475	569	661	755	851	945	1040	1134	1320	1509	1696	1883
	108	428	535	639	747	851	958	1062	1168	1273	1485	1696	1906	2117
120	475	592	709	827	945	1062	1177	1296	1415	1650	1882	2117	2351	

■ Cord Loop Hardware is recommended on sizes within the shaded area.
 Motorized lift systems are not offered within the shaded area.

LIFT SYSTEM AND DESIGN UPGRADES			ADD
Cord Lock	Top Down-Bottom Up		\$85
Cordless Lift & Lock	Bottom Up		No Charge
	Top Down-Bottom Up		\$108
Cordless Ultra	Bottom Up		\$108
	Top Down-Bottom Up		\$215
Cord Loop	Bottom Up		\$108
	Top Down-Bottom Up		\$215
DESIGNER UPGRADE OPTIONS (Add to any Lift System Upgrade Above - Not available on Cord Lock)			ADD
Metallic Hardware (Not available on Lift & Lock or Cord Lock)			\$30
Fabric Wrapped Hardware (Not available on Cord Lock)			\$48
MOTORIZATION*			MORE INFO
7.4V PowerTouch Rechargeable			Pg 37 \$100
7.4V Simplicity Rechargeable Motorization - Motor with Integrated Battery			Pg 32 \$300
Plug-In Charger for Li-Ion Battery Pack (used for PowerTouch and Simplicity Rechargeable and is required)			Pg 34 \$30
Simplicity 14 Channel White Remote			Pg 36 \$50
Simplicity Smart Controller (NEO)			Pg 40 \$280
Top Down-Bottom Up Motorization and Solar Charge Option Pricing			Pg 11
7.4V EZ Charge Extension Wand	Wall Mount Receiver Kit 7.4V	\$18	For More Information Page 39
	Extendable Wand 7.4V	\$32	
ADDITIONAL OPTIONS		MORE INFO	
Two-On-One/Three-On-One Head Rail		Price each panel as a separate shade, including lift system upgrades, add together.	
For additional options and surcharges refer to page 11.		Pg 11	

*Motorized Pricing Examples pages 81, 128, 130 and 133

Prelude Shade Collection

PRICING

Prelude 1 1/4" Light Filtering

PRICE GROUP 3

Base Grid

(Must add lift control option)

		Width In Inches												
		24	30	36	42	48	54	60	66	72	84	96	108	120
Length In Inches	36	224	247	286	317	351	381	413	441	475	543	611	678	750
	42	239	274	305	343	381	414	453	487	524	601	675	751	833
	48	253	293	335	372	413	451	490	533	571	667	761	856	952
	54	270	310	353	399	444	486	539	589	644	751	856	964	1070
	60	289	333	381	428	473	539	597	654	715	833	950	1070	1188
	66	301	351	405	461	524	589	654	721	786	918	1047	1176	1308
	72	317	367	428	503	574	644	715	786	856	1000	1141	1284	1426
	78	335	390	466	543	620	696	777	853	928	1080	1237	1389	
	84	342	417	503	585	667	751	833	918	1000	1165	1330		
	90	360	449	539	626	715	805	892						
96	384	477	574	667	761	856	950							

■ Cord Loop Hardware is recommended on sizes within the shaded area.

This is base grid, choose Cordless or PowerTouch hardware option and add to base grid (cord lock not available)

Prelude 1 1/4" Blackout

PRICE GROUP 4

Base Grid

(Must add lift control option)

		Width In Inches												
		24	30	36	42	48	54	60	66	72	84	96	108	120
Length In Inches	36	280	310	357	399	435	476	514	551	595	678	766	846	938
	42	300	341	381	430	476	518	565	607	654	752	845	940	1041
	48	315	367	417	464	514	564	613	667	714	833	950	1071	1191
	54	338	387	441	498	553	607	674	736	805	940	1071	1207	1338
	60	360	416	476	534	589	674	747	817	892	1041	1189	1338	1484
	66	376	435	505	577	655	736	817	902	981	1147	1308	1471	1634
	72	399	458	534	627	717	805	892	981	1071	1249	1427	1605	1782
	78	417	488	583	678	774	870	970	1066	1160	1350	1545	1736	
	84	429	523	627	732	833	940	1041	1147	1249	1456	1661		
	90	450	559	674	782	892	1005	1116						
96	480	597	717	833	950	1071	1189							

■ Cord Loop Hardware is recommended on sizes within the shaded area.

This is base grid, choose Cordless or PowerTouch hardware option and add to base grid (cord lock not available)

LIFT SYSTEM AND DESIGN UPGRADES			ADD
Cordless Ultra	Bottom Up		\$108
	Top Down-Bottom Up		\$215
MOTORIZATION*			MORE INFO
7.4V PowerTouch Rechargeable			Pg 37 \$100
ADDITIONAL OPTIONS			MORE INFO
For additional options and surcharges refer to page 11.			Pg 11

*Motorized Pricing Examples pages 82, 129, 131 and 134

Prelude Shade Collection PRICING

Prelude 2" Light Filtering

PRICE GROUP 5 Cordless Lift & Lock

		Width In Inches												
		24	30	36	42	48	54	60	66	72	84	96	108	120
Length In Inches	36	198	219	253	280	310	337	365	389	418	480	539	598	661
	42	212	241	269	304	337	367	399	429	462	530	596	662	735
	48	222	259	295	328	365	399	433	471	505	587	672	755	841
	54	239	274	311	352	390	428	476	522	569	662	755	851	944
	60	255	294	337	377	417	476	527	579	631	735	839	944	1048
	66	265	310	357	407	463	522	579	637	694	809	924	1038	1154
	72	280	324	377	444	506	569	631	694	755	882	1006	1133	1258
	78	295	345	411	480	547	615	684	752	819	953	1091	1168	
	84	303	369	444	518	587	662	735	809	882	1027	1173		
	90	316	397	476	553	631	710	789	866	944	1100	1258		
	96	338	422	506	587	672	755	839	924	1006	1173	1341		
	108	381	476	569	662	755	851	944	1038	1133	1235			
120	422	527	631	735	839	944	1048	1153	1258					

■ Cord Loop Hardware is recommended on sizes within the shaded area.
Simplicity Motors are not available in the shaded area.

LIFT SYSTEM AND DESIGN UPGRADES			ADD
Cordless Lift & Lock	Bottom Up		No Charge
	Top Down-Bottom Up		\$108
Cordless Ultra	Bottom Up		\$108
	Top Down-Bottom Up		\$215
Cord Loop	Bottom Up		\$108
	Top Down-Bottom Up		\$215
DESIGNER UPGRADE OPTIONS (Add to any Lift System Upgrade Above)			ADD
Metallic Hardware			\$30
Fabric Wrapped Hardware			\$48
MOTORIZATION*			MORE INFO
7.4V Simplicity Rechargeable Motorization - Motor with Integrated Battery			Pg 32 \$300
Plug-In Charger for Li-Ion Battery Pack (used for PowerTouch and Simplicity Rechargeable and is required)			Pg 34 \$30
Simplicity 14 Channel White Remote			Pg 36 \$50
Simplicity Smart Controller (NEO)			Pg 40 \$280
Top Down-Bottom Up Motorization and Solar Charge Option Pricing			Pg 11
7.4V EZ Charge Extension Wand	Wall Mount Receiver Kit 7.4V	\$18	For More Information Page 39
	Extendable Wand 7.4V	\$32	
ADDITIONAL OPTIONS			MORE INFO
For additional options and surcharges refer to page 11.			Pg 11

*Motorized Pricing Examples pages 82, 129, 131 and 134

Prelude Shade Collection

PRICING

Prelude 2" Blackout

PRICE GROUP 6

Cordless Lift & Lock

		Width In Inches												
		24	30	36	42	48	54	60	66	72	84	96	108	120
Length In Inches	36	267	295	340	378	416	454	492	526	565	647	728	808	892
	42	285	327	363	411	454	494	539	579	624	716	804	895	993
	48	300	351	399	444	492	538	583	634	680	794	906	1021	1135
	54	324	369	420	475	527	577	643	703	767	895	1021	1149	1273
	60	343	398	454	509	564	643	710	780	851	993	1134	1273	1415
	66	358	416	482	549	625	703	780	860	937	1094	1248	1401	1557
	72	378	435	509	598	683	767	851	937	1021	1191	1359	1529	1697
	78	399	465	555	647	737	829	924	1017	1104	1288	1472	1655	
	84	408	498	598	698	794	895	993	1094	1191	1387	1585		
	90	428	534	643	747	851	960	1064	1168	1273	1487	1697		
	96	456	569	683	794	906	1021	1134	1248	1359	1585	1809		
	108	513	643	767	895	1021	1149	1273	1401	1529				
120	569	710	851	993	1134	1273	1415	1556	1697					

■ Cord Loop Hardware is recommended on sizes within the shaded area.
Simplicity Motors are not available in the shaded area.

LIFT SYSTEM AND DESIGN UPGRADES			ADD
Cordless Lift & Lock	Bottom Up		No Charge
	Top Down-Bottom Up		\$108
Cordless Ultra	Bottom Up		\$108
	Top Down-Bottom Up		\$215
Cord Loop	Bottom Up		\$108
	Top Down-Bottom Up		\$215
DESIGNER UPGRADE OPTIONS (Add to any Lift System Upgrade Above)			ADD
Metallic Hardware			\$30
Fabric Wrapped Hardware			\$48
MOTORIZATION*			MORE INFO
7.4V Simplicity Rechargeable Motorization - Motor with Integrated Battery			Pg 32 \$300
Plug-In Charger for Li-Ion Battery Pack (used for PowerTouch and Simplicity Rechargeable and is required)			Pg 34 \$30
Simplicity 14 Channel White Remote			Pg 36 \$50
Simplicity Smart Controller (NEO)			Pg 40 \$280
Top Down-Bottom Up Motorization and Solar Charge Option Pricing			Pg 11
7.4V EZ Charge Extension Wand	Wall Mount Receiver Kit 7.4V	\$18	For More Information Page 39
	Extendable Wand 7.4V	\$32	
ADDITIONAL OPTIONS			MORE INFO
For additional options and surcharges refer to page 11.			Pg 11

*Motorized Pricing Examples pages 82, 129, 131 and 134

Prelude Shade Collection

PRICING

Prelude 3/4" Light Filtering
 Prelude 2" Light Filtering

PRICE GROUP 7
Ovation Cellular Slider

		Width In Inches																	
		24	30	36	42	48	54	60	66	72	78	84	96	108	120	132	144	156	168
Length In Inches	36	487	526	572	615	653	695	739	778	820	867	903	976	1052	1130	1207	1287	1367	1445
	42	514	565	617	666	706	755	805	849	900	946	988	1074	1156	1250	1343	1434	1525	1617
	48	550	601	662	714	761	814	869	922	975	1022	1076	1176	1266	1368	1467	1570	1671	1772
	54	581	642	703	763	814	871	928	993	1052	1104	1165	1273	1374	1485	1598	1707	1822	1932
	60	613	678	744	809	869	931	996	1064	1125	1187	1249	1369	1482	1603	1729	1848	1972	2099
	66	648	719	791	860	922	991	1056	1139	1201	1273	1330	1467	1588	1722	1849	1980	2110	2242
	72	684	755	833	911	985	1053	1124	1207	1279	1354	1417	1570	1696	1844	1991	2138	2285	2431
	78	719	797	880	963	1040	1115	1191	1281	1357	1435	1504	1664	1803	1960	2113	2271	2426	2582
	84	755	838	922	1017	1097	1176	1258	1352	1435	1518	1592	1763	1913	2075	2242	2408	2568	2735
	90	786	874	971	1068	1149	1237	1327	1427	1514	1601	1684	1863	2018	2200	2381	2563	2745	2928
	96	819	916	1017	1116	1207	1296	1398	1499	1592	1686	1772	1962	2128	2314	2502	2690	2878	3063
	102	850	950	1061	1171	1259	1357	1463	1567	1669	1772	1857	2065	2238	2432	2621	2816	3006	3199
108	895	999	1115	1227	1323	1426	1545	1653	1759	1867	1958	2176	2360	2559	2747	2939	3129	3320	
114	940	1047	1172	1287	1387	1493	1624	1732	1845	1961	2055	2287	2483	2685	2884	3080	3278	3476	
120	981	1095	1227	1348	1454	1561	1706	1814	1935	2057	2153	2399	2604	2811	3017	3225	3427	3638	

Prelude 3/4" Blackout
 Prelude 2" Blackout

PRICE GROUP 8
Ovation Cellular Slider

		Width In Inches																	
		24	30	36	42	48	54	60	66	72	78	84	96	108	120	132	144	156	168
Length In Inches	36	657	709	771	830	880	940	997	1048	1108	1169	1219	1319	1420	1525	1629	1737	1844	1950
	42	696	766	831	898	952	1018	1087	1144	1214	1276	1332	1451	1560	1689	1811	1935	2058	2183
	48	741	809	895	963	1027	1098	1172	1246	1318	1380	1452	1588	1707	1847	1980	2121	2255	2392
	54	784	866	948	1028	1098	1176	1251	1339	1420	1492	1570	1718	1855	2005	2157	2304	2459	2609
	60	829	914	1004	1094	1172	1255	1344	1435	1519	1601	1685	1848	2001	2163	2334	2493	2661	2831
	66	874	969	1067	1160	1246	1338	1427	1535	1618	1718	1795	1980	2146	2324	2495	2675	2849	3025
	72	922	1020	1124	1228	1327	1421	1518	1629	1724	1826	1914	2122	2289	2489	2686	2884	3082	3281
	78	969	1077	1187	1300	1402	1504	1608	1729	1832	1938	2031	2246	2433	2645	2852	3062	3276	3485
	84	1018	1129	1244	1370	1481	1588	1697	1824	1938	2050	2149	2379	2582	2801	3025	3248	3469	3692
	90	1063	1182	1311	1441	1552	1671	1790	1927	2044	2161	2273	2515	2724	2970	3212	3460	3708	3953
	96	1103	1235	1372	1506	1629	1748	1886	2022	2149	2276	2390	2649	2873	3125	3377	3629	3883	4135
	102	1147	1284	1430	1580	1700	1832	1975	2116	2253	2390	2508	2787	3021	3282	3538	3801	4057	4319
108	1207	1348	1504	1655	1787	1923	2085	2229	2373	2521	2643	2939	3186	3454	3709	3966	4226	4483	
114	1268	1411	1582	1737	1873	2016	2192	2338	2491	2646	2776	3086	3350	3624	3894	4159	4426	4694	
120	1326	1479	1655	1819	1961	2106	2302	2447	2613	2777	2908	3236	3515	3794	4072	4352	4625	4911	

PRODUCT INFORMATION	
See Page 41 for detailed information.	
DESIGN UPGRADES	
Left or Right Stack	Included, specify when ordering
Center Stack	Add \$108
Split Stack*	Price by dividing the full width measurement in half. Price as two separate units and add together.
Dual Panel**	Price as two separate units and add together.
FABRIC SURCHARGES	
Prints and Duotones	Add 20%
Flame Resistant 3/8" Double Cell	Add 30%
Flame Resistant 3/4" Single Cell	Add 30%

* Split stack sliders are available in widths up to 240". If the width exceeds 120", it will be fabricated as two separate sliders. The supplied valance will create the appearance of a single slider.

** A Dual Panel Stack Slider has a center opening design with a different fabric on each side, each of which can span the full width of the window. Both panels will be of equal width unless otherwise specified.

Prelude Shade Collection

PRICING

Prelude 3/4" Light Filtering

PRICE GROUP 9

Starburst Arches

Quarter Rounds

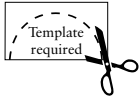

For widths wider than 58"

		Width In Inches										
		24	30	36	42	48	54	60	66	72	78	84
Length In Inches	Stationary Starburst	317	361	409	465	559	639	720	814	916	1022	1137
	Movable Starburst	449	507	579	653	779	872	981	1098	1225	1348	1482
	Stationary Quarter Round	413	471	532	605							
	Movable Quarter Round	NOT AVAILABLE										

Prelude 3/4" Blackout

PRICE GROUP 10

Starburst Arches

Quarter Rounds

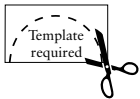

For widths wider than 58"

		Width In Inches						
		24	30	36	42	48	54	60
Length In Inches	Stationary Starburst	429	488	553	628	755	865	973
	Movable Starburst	605	684	780	880	1052	1177	1326
	Stationary Quarter Round	558	634	717	816			
	Movable Quarter Round							

Product Information: See page 46 for detailed information. Templates required on non-perfect non-movable Starburst Arches and Quarter Rounds. Movable Starburst Arch shades are for inside and shallow mount applications only.

FABRIC SURCHARGES		ADD
Debut 1/2" Single Cell Print Fabric	Includes: Homespun, Country Woven, Florance, Strata, Angel Hair, Blossom, Terrazzo and Strie	20%
Debut 1/2" Double Cell Print Fabric Debut 3/4" Single Cell Print Fabric	Includes: Homespun, Country Woven, Florance, Strata and Angel Hair	20%
Premiere Fabric	Includes: Homespun, Country Woven, Florance, Spheres, Strata, Tuscan Scroll, Angel Hair, Blossom, and Gradients	20%
Symphony Fabric	Symphony Prints and Duotones	20%
	Symphony Double Cell Flame Resistant	30%
PRICING INFORMATION		
Starburst Arches	Price according to the largest radius measurement. If the height is greater than the width, take height X 2 and use that number to determine pricing. Metallic rails available.	
Quarter Rounds	Price according to the largest radius measurement.	
HARDWARE UPGRADE SURCHARGES* AND ACCESSORIES		ADD
5-10 Foot Expandable Pole - Black		\$54

Prelude Shade Collection
PRICING

Prelude 3/4" Light Filtering

PRICE GROUP 11
Sunset Movable Arches

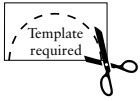

For widths wider than 58"

		Width In Inches										
		24	30	36	42	48	54	60	66	72	78	84
Length In Inches	Half Round	411	457	486	545	581	653	691	760	830	896	988
	36	532	582	610	653	680	732	753	793	830	868	900
	42	559	618	643	708	732	790	814	860	900	946	988
	48	595	653	687	751	779	825	874	922	971	1021	1074

FABRIC SURCHARGES		ADD
Debut 1/2" Single Cell Print Fabric	Includes: Homespun, Country Woven, Florance, Strata, Angel Hair, Blossom, Terrazzo and Strie	20%
Debut 1/2" Double Cell Print Fabric Debut 3/4" Single Cell Print Fabric	Includes: Homespun, Country Woven, Florance, Strata and Angel Hair	20%
Premiere Fabric	Includes: Homespun, Country Woven, Florance, Spheres, Strata, Tuscan Scroll, Angel Hair, Blossom, and Gradients	20%
Symphony Fabric	Symphony Prints and Duotones	20%
	Symphony Double Cell Flame Resistant	30%
HARDWARE UPGRADE SURCHARGES AND ACCESSORIES		ADD
3 Foot Expandable Pole - Silver		\$30
5-10 Foot Expandable Pole - Black		\$54

Prelude 3/4" Blackout

PRICE GROUP 12
Sunset Movable Arches

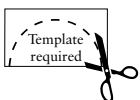

For widths wider than 58"

		Width In Inches						
		24	30	36	42	48	54	60
Length In Inches	Half Round	553	617	655	735	784	880	933
	36	717	785	824	880	919	988	1017
	42	755	834	869	953	989	1065	1098
	48	799	880	928	1015	1052	1114	1182

Product Information: See pages 45 for detailed information. Templates required on non-perfect Sunset Arches.

FABRIC SURCHARGES		ADD
Premiere Fabric Prints	Includes: Homespun, Country Woven, Florance, Spheres, Strata, Tuscan Scroll, Angel Hair, Blossom, and Gradients	20%
HARDWARE UPGRADE SURCHARGES AND ACCESSORIES		ADD
3 Foot Expandable Pole - Silver		\$30
5-10 Foot Expandable Pole - Black		\$54

Prelude Shade Collection
PRICING

Prelude 3/4" Light Filtering

PRICE GROUP 13
Trapezoids and Octagons

		Width In Inches						
		24	30	36	42	48	54	60
Length In Inches	36	565	601	642	685	726	766	803
	42	586	627	672	720	766	808	854
	48	605	653	704	755	803	850	902
	54	626	675	732	786	839	895	947
	60	646	701	763	820	875	943	999
	66	667	726	793	855	919	986	1043
	72	685	748	820	891	960	1026	1098

Product Information: See page 47-48 for detailed information.

FABRIC SURCHARGES		ADD
Debut 1/2" Single Cell Print Fabric	Includes: Honespun, Country Woven, Florance, Strata, Angel Hair, Blossom, Terrazzo and Strie	20%
Debut 1/2" Double Cell Print Fabric Debut 3/4" Single Cell Print Fabric	Includes: Honespun, Country Woven, Florance, Strata and Angel Hair	20%
Premiere Fabric Prints	Includes: Honespun, Country Woven, Florance, Spheres, Strata, Tuscan Scroll, Angel Hair, Blossom, and Gradients	20%
Symphony Fabric	Symphony Prints and Duotones	20%
	Symphony Double Cell Flame Resistant	30%

Prelude 3/4" Blackout

PRICE GROUP 14
Trapezoids

		Width In Inches						
		24	30	36	42	48	54	60
Length In Inches	36	766	809	866	925	979	1032	1082
	42	792	845	906	973	1032	1089	1152
	48	816	880	949	1020	1082	1147	1218
	54	845	911	989	1063	1133	1207	1279
	60	871	945	1028	1108	1183	1271	1348
	66	900	979	1070	1153	1242	1330	1409
	72	925	1010	1108	1201	1295	1386	1481

Product Information: See page 47-48 for detailed information. **Trapezoid orders must be faxed in with a diagram that includes the measurements for 4 sides.** No templates are required for Trapezoid Shades.

FABRIC SURCHARGES		ADD
Premiere Fabric Prints	Includes: Honespun, Country Woven, Florance, Spheres, Strata, Tuscan Scroll, Angel Hair, Blossom, and Gradients	20%

Comfortex Skylight and Greenhouse Shades

PRICING

Prelude 3/4" Light Filtering

PRICE GROUP 15 Skylight Shading System

		Width In Inches						
		24	30	36	42	48	54	60
Length In Inches	36	405	462	512	577	627	720	829
	42	429	490	559	618	685	790	907
	48	451	526	592	662	736	846	975
	54	481	558	631	704	798	919	1056
	60	499	589	668	748	856	986	1133
	66	526	617	703	786	913	1051	1208
	72	558	652	732	820	963	1108	1273

Prelude 3/4" Blackout

PRICE GROUP 16 Skylight Shading System

		Width In Inches						
		24	30	36	42	48	54	60
Length In Inches	36	548	624	693	777	845	973	1118
	42	579	661	755	834	925	1065	1225
	48	607	709	798	895	994	1143	1314
	54	648	752	851	949	1078	1242	1427
	60	672	795	901	1010	1156	1330	1530
	66	709	831	948	1063	1232	1416	1631
	72	752	876	989	1108	1300	1493	1718

Product Information: See page 49 for detailed information.

HARDWARE UPGRADE SURCHARGES AND ACCESSORIES	ADD
3 Foot Expandable Pole - Silver	\$30
5-10 Foot Expandable Pole - Black	\$54



Standard Hardware



**7.4V Rechargeable
Simplicity Motorization**



**Cord Loop
Hardware**



**7.4V Rechargeable
Powertouch**



**Cordless Ultra
Hardware**



**Ovation
Hardware**



**Cordless Lift & Lock
Hardware**



**Specialty Shape
Hardware**

Prelude Cellular $\frac{3}{4}$ " STANDARD CORD LOCK SHADES HARDWARE SYSTEM

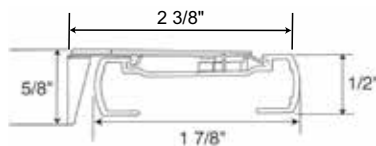

Deluxe Cord Lock Rail

- Depth of rail: $1\frac{7}{8}$ "
- Depth of rail and bracket: $2\frac{3}{8}$ "
- Height: $\frac{1}{2}$ "
- Height of bracket: $\frac{5}{8}$ "

Hardware Features

Hardware colors for Cellular fabrics	Color coordinated head and bottom rails with white cord and tassel
--------------------------------------	--

Upgrades

Fabric Wrapped Upgrade	Fabric used is same fabric as the shade. Back of rail is white to outside. Color coordinated end caps.
------------------------	--

Mounting Dimensions	Deluxe Cord Lock Rail	
Minimum Shallow Mount	$\frac{3}{4}$ "	
Minimum Flush Inside Mount	$2\frac{3}{8}$ "	
Minimum Outside Mount	$\frac{3}{4}$ "	
Minimum Side Mount	$1\frac{3}{8}$ "	
Minimum Flush Side Mount	$1\frac{3}{8}$ "	

Maximum End Mount Shade width 36"

Recommended Side Mounting Method	<ul style="list-style-type: none"> • See figure A on pg 25 for recommended mounting method for side mount shades • Width limit for side mount brackets is 36"
---	---

Finished Dimensions

Inside and Side Mount

	<ul style="list-style-type: none"> • Fabric will measure ordered width less: $\frac{3}{8}$" • Head rail* will measure ordered width less: $\frac{3}{16}$"
--	---

Outside Mount

	<ul style="list-style-type: none"> • Fabric will measure ordered width • Head rail* will measure ordered width plus: $\frac{3}{16}$"
--	---

Exact (End Cap to End Cap) Mount

Cord Length

	<ul style="list-style-type: none"> • Comfortex complies with all WCMA/ANSI standards and as such the default cord length will be 40% of the ordered shade length. Custom lengths are available.
--	--

* Head rail measurements include endcaps. Width and length measurements may vary +/- $\frac{1}{8}$ "

Prelude Cellular

STANDARD CORD LOCK SHADES HARDWARE SYSTEM

Applications

- Standard Rectangular
- Top Down - Bottom Up
- Two-On-One Head Rail

Things to Consider

- If child or pet safety is a concern, consider Cordless Ultra.
- Larger shades can be difficult to operate. Consider Cord Loop hardware.
- If privacy is an issue, consider Top Down-Bottom Up options.

Ordering Information for Standard Cord Lock Shades

Standard Rectangular

- Specify IB or OB mount, and left or right lift cord.

Top Down - Bottom Up

- Specify IB or OB mount.
Top Down - Bottom Up Shades are made with two operating cord locks, one on the left and one on the right side of shade. The right cord operates the middle rail and left cord operates the bottom.
- On Top Down - Bottom Up Shades, an extra two-cell fabric gasket attached to the top head rail and acts as a seal to eliminate light leakage between the head rail and middle rail when the shade is closed.

(2-cell fabric insert)

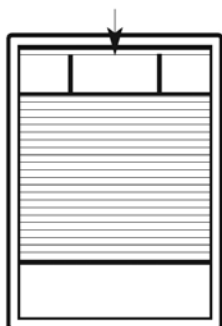

Two-On-One Head Rail

Two-On-One Head Rail Shades operate as two separate shades on one head rail.

- Specify IB or OB mount.
- Specify panel sizes.
- Maximum width in a single panel depends on fabric type. See page 2 for maximum single panel width.
- ¼" to maximum ½" Space between panels.

Recommended Mounting Method for Side Mounting Shades

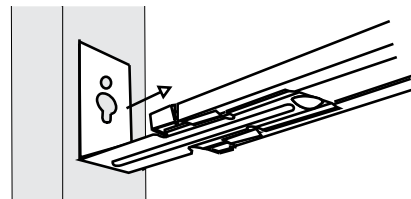
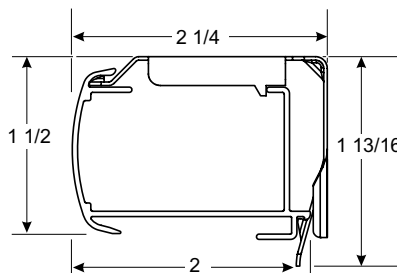

Figure A

Refer to the installation instructions on Comfortex.com/comfortex-dealers or the OnDemand Mobile Library for further details on side mounting shades.

Prelude Cellular 3/4" & 2" CORD LOOP HARDWARE SYSTEM



Cord Loop Rail Dimensions

- Depth of rail: 2"
- Depth of rail and bracket: 2 1/4"
- Height of rail: 1 1/2"
- Height of bracket: 1 13/16"

Hardware Features	
Standard Hardware colors for Comfortex Prelude	Color coordinated head, bottom rails and end caps with a white cord and tensioner
Upgrades	
Fabric Wrapped Upgrade	Fabric used is same fabric as the shade. Back of rail is white to outside. Color coordinated end caps for rails.
Designer Metallic Upgrade	<ul style="list-style-type: none"> • Smooth faced Oil Rubbed Bronze head, bottom rails and end caps with bronze tensioner and bronze cord.

Mounting Dimensions	Cord Loop Hardware System 3/4" & 2"
Minimum Inside Mount	3/4"
Minimum Flush Inside Mount	2 1/8"
Minimum Outside Mount Flat Vertical Surface	1 1/2"
Maximum End Mount Shade width 48, maximum width for 2" fabric end mount is 42"	

Finished Dimensions -Standard Rectangular and Top Down-Bottom Up		
Inside Mount	3/4" Prelude	2" Prelude
	<ul style="list-style-type: none"> • Fabric will measure ordered width less: 3/8" • Head rail* will measure ordered width less: 1/4" • Length will measure ordered length 	<ul style="list-style-type: none"> • Fabric will measure ordered width less: 5/8" • Head rail* will measure ordered width less: 1/4" • Length will measure ordered length
Inside Mount with Hold Down Brackets		
	<ul style="list-style-type: none"> • Fabric will measure ordered width less: 5/8" • Head rail* will measure ordered width less: 1/2" • Bottom rail* will measure ordered width less: 1/2" • Length will measure ordered length 	<ul style="list-style-type: none"> • Fabric will measure ordered width less: 5/8" • Head rail* will measure ordered width less: 1/2" • Bottom rail* will measure ordered width less: 1/2" • Length will measure ordered length
Outside Mount		
	<ul style="list-style-type: none"> • Fabric will measure ordered width less: 1/8" • Head rail* will measure ordered width • Length will measure ordered length 	<ul style="list-style-type: none"> • Fabric will measure ordered width less: 3/8" • Head rail* will measure ordered width • Length will measure ordered length
* Head rail measurements include endcaps. Width and length measurements may vary +/- 1/8"		

**NOTE: An additional 1/4" width deduction is taken on shades ordered Inside Mount with hold down brackets.
An additional 1/4" width deduction is taken from the fabric with the Top Down-Bottom Up option for 2".**

Prelude Cellular

CORD LOOP HARDWARE SYSTEM

Applications

- Standard Rectangular
- Top Down - Bottom Up
- Two-On-One Head Rail

Cord Loop Hardware System Features

Cord loops are available 18" to 10' lengths. Please specify length when ordering. Standard loop sizes are as follows:

Shade Length	Standard Loop
Up to 18"	18"
18" to 42"	2' (24")
42 $\frac{1}{8}$ " to 54"	3' (36")
54 $\frac{1}{8}$ " to 72"	4' (48")
72 $\frac{1}{8}$ " to 90"	5' (60")
90 $\frac{1}{8}$ " to 110"	6' (72")
110 $\frac{1}{8}$ " and greater	8' (96")

Cord loops over 6' in length will be white.

Ordering Information for Cord Loop Hardware Shades

Standard Rectangular

- Specify IB or OB mount, and left or right cord loop.
- Specify cord loop length when ordering.

Top Down - Bottom Up

- Specify IB or OB mount.
Specify cord loop length when ordering.
- Controls are the right cord loop operates the middle rail and left cord loop operates the bottom. Reverse controls are not available.
- On Top Down-Bottom Up shades a fabric insert is standard; this is an extra 2 cell fabric gasket attached to the top head rail and acts as a seal to eliminate light leakage between the head rail and center rail when the shade is closed

Two-On-One Head Rail

- Two-On-One Head Rail Shades operate as two separate shades on one head rail.
- Specify IB or OB mount.
- Specify panel sizes.
- Specify cord loop length when ordering.
- See page 2 for maximum single panel width.
- $\frac{1}{4}$ " Space between panels.

Prelude Cellular $\frac{3}{4}$ ", $1\frac{1}{4}$ " & 2" CORDLESS ULTRA HARDWARE SYSTEM

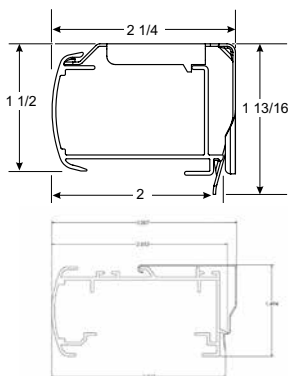
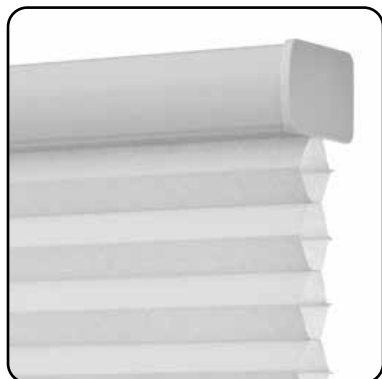

$\frac{3}{4}$ " & 2" Cord Loop Rail Dimensions

- Depth of rail: 2"
- Depth of rail and bracket: $2\frac{1}{4}$ "
- Height of rail: $1\frac{1}{2}$ "
- Height of bracket: $1\frac{13}{16}$ "

$1\frac{1}{4}$ " Pleat Fabric Rail Dimensions

- Depth of rail: 2.827"
- Depth of rail and bracket: 3.007"
- Height of rail and bracket: 1.494"

Hardware Features	
Standard Hardware colors for Comfortex Prelude	Color coordinated head, middle and bottom rails.
Upgrades	
Fabric Wrapped Upgrade	Fabric used is same fabric as the shade. Back of rail is white to outside. End caps on fabric wrapped head, middle and bottom rails are color coordinated
Designer Metallic Upgrade	<ul style="list-style-type: none"> • Smooth faced Designer Oil Rubbed Bronze head, middle, bottom rails and end caps •

Mounting Dimensions	Cordless Ultra Hardware System		
	$\frac{3}{4}$ " Prelude	$1\frac{1}{4}$ " Prelude	2" Prelude
Minimum Inside Mount	$\frac{3}{4}$ "	$1\frac{5}{8}$ "	$\frac{3}{4}$ "
Minimum Flush Inside Mount	$2\frac{1}{8}$ "	3"	$2\frac{1}{8}$ "
Minimum Outside Mount Flat Vertical Surface	$1\frac{1}{2}$ "	$1\frac{1}{2}$ "	$1\frac{1}{2}$ "
Maximum End Mount Shade width 48, maximum width for 2" fabric end mount is 42"			

Finished Dimensions			
Inside Mount	$\frac{3}{4}$ " Prelude	$1\frac{1}{4}$ " Prelude	2" Prelude
	<ul style="list-style-type: none"> • Fabric will measure ordered width less: $\frac{3}{8}$" • Head rail* will measure ordered width less: $\frac{1}{4}$" • Length will measure ordered length 	<ul style="list-style-type: none"> • $-\frac{3}{8}$" • $-\frac{1}{4}$" • ordered length 	<ul style="list-style-type: none"> • $-\frac{3}{8}$" • $-\frac{1}{4}$" • ordered length
Inside Mount with Hold Down Brackets	<ul style="list-style-type: none"> • Fabric will measure ordered width less: $\frac{5}{8}$" • Head rail* will measure ordered width less: $\frac{1}{2}$" • Bottom rail* will measure ordered width less: $\frac{1}{2}$" • Length will measure ordered length 	<ul style="list-style-type: none"> • $-\frac{5}{8}$" • $-\frac{1}{2}$" • $-\frac{1}{2}$" • ordered length 	<ul style="list-style-type: none"> • $-\frac{5}{8}$" • $-\frac{1}{2}$" • $-\frac{1}{2}$" • ordered length
Outside Mount	<ul style="list-style-type: none"> • Fabric will measure ordered width less: $\frac{1}{8}$" • Head rail* will measure ordered width • Length will measure ordered length 	<ul style="list-style-type: none"> • $-\frac{1}{8}$" • ordered width • ordered length 	<ul style="list-style-type: none"> • $-\frac{1}{8}$" • ordered width • ordered length
End Mount/Side Mount	<ul style="list-style-type: none"> • Fabric will measure ordered width less: $\frac{5}{8}$" • Head rail* will measure ordered width less: $\frac{1}{2}$" • Length will measure ordered length 	<ul style="list-style-type: none"> • $-\frac{5}{8}$" • $-\frac{1}{2}$" • ordered length 	<ul style="list-style-type: none"> • $-\frac{5}{8}$" • $-\frac{1}{2}$" • ordered length

* Head rail measurements include endcaps. Width and length measurements may vary +/- $\frac{1}{8}$ " and +/- $\frac{1}{8}$ " for $1\frac{1}{4}$ " Prelude

NOTE: An additional $\frac{1}{4}$ " width deduction is taken on shades ordered Inside Mount with hold down brackets.

Prelude Cellular

CORDLESS ULTRA HARDWARE SYSTEM

Applications

- Standard Rectangular
- Top Down - Bottom Up
- Two-On-One Head Rail
- Three-On-One Head Rail

Ordering Information for Cordless Ultra Hardware Shades

Standard Rectangular

- Specify IB or OB mount.

Top Down - Bottom Up

- Specify IB or OB mount.

Accessories

- 3' Expandable Pole - Silver



Specially designed pole end fits into the handle on the bottom rail and allows for easy operation.



Things to Consider

- Is the top of your window out of reach? You can order an extension pole to reach but it can still be tricky. You may want to consider Cord Loop hardware.
- For shades mounted on doors, you may want to order hold down brackets.
- If privacy is an issue, consider Top Down-Bottom Up options.

CORDLESS THREE-ON-ONE SIZE STANDARDS*

Minimum Width (per panel)	16"
Minimum Width (Overall)	48"
Maximum Width (per panel)	120"
Maximum Width (Overall)	174"
Minimum Height	12"
Maximum Height	84"
Maximum Area (per panel) (Sq/Ft)	70

*Three-On-One head rail is not available in Top Down-Bottom Up



Prelude Cellular 3/4" & 2" CORDLESS LIFT & LOCK HARDWARE SYSTEM

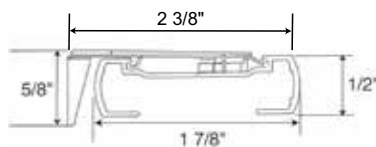

Deluxe Top Rail

- Depth of rail: 1 7/8"
- Depth of rail and bracket: 2 3/8"
- Height: 1/2"
- Height of bracket: 5/8"

Hardware Features		
Standard Hardware colors for Comfortex Prelude	Color coordinated head, middle and bottom rails with color coordinated push button/handle on the middle and/or bottom rails	
Upgrades		
Fabric Wrapped Upgrade	Fabric used is same fabric as the shade. Back of rail is white to outside. All shades will have a white push button/handle on the middle /bottom rail. White end caps.	
Mounting Dimensions		
	Standard Head Rail 3/4" & 2"	
Minimum Inside Mount	3/4"	
Minimum Flush Inside Mount	2 1/8"	
Minimum Outside Mount Flat Vertical Surface	1 1/2"	
Maximum End Mount Shade width 48"		
Finished Dimensions		
Inside Mount	3/4" Prelude	2" Prelude
	<ul style="list-style-type: none"> • Fabric will measure ordered width less: 3/8" • Head rail* will measure ordered width less: 3/16" • Length will measure ordered length 	<ul style="list-style-type: none"> • Fabric will measure ordered width less: 3/8" • Head rail* will measure ordered width less: 1/4" • Length will measure ordered length
Outside Mount		
	<ul style="list-style-type: none"> • Fabric will measure ordered width less: 1/8" • Head rail* will measure ordered width • Length will measure ordered length 	<ul style="list-style-type: none"> • Fabric will measure ordered width less: 1/8" • Head rail* will measure ordered width • Length will measure ordered length
End Mount/ Side Mount		
	<ul style="list-style-type: none"> • Fabric will measure ordered width less: 1/2" • Head rail* will measure ordered width less: 1/2" • Length will measure ordered length 	<ul style="list-style-type: none"> • Fabric will measure ordered width less: 5/8" • Head rail* will measure ordered width less: 1/2" • Length will measure ordered length
* Head rail measurements include endcaps. Width and length measurements may vary +/- 1/8"		

NOTE: An additional 1/4" width deduction is taken on shades ordered Inside Mount with hold down brackets

Prelude Cellular CORDLESS LIFT & LOCK HARDWARE SYSTEM

Applications

- Standard Rectangular
- Top Down - Bottom Up
- Two-On-One Head Rail
- Three-On-One Head Rail

Ordering Information for Cordless Lift & Lock Hardware Shades Standard Rectangular

- Specify IB or OB mount and rail color.

Top Down - Bottom Up

- Specify IB or OB mount.

Things to Consider

- To operate a Cordless Lift & Lock Shade, the middle or bottom rails must be accessible. An extension pole is not available for Cordless Lift & Lock Shades.
- For shades mounted on doors, you may want to order hold down brackets.
- If privacy is an issue, consider Top Down-Bottom Up options.

Cordless Lift & Lock Shade Operation

Cordless Lift & Lock Shades are operated using the push button handle located in the center of the bottom rail.

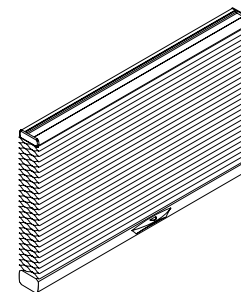

To raise or lower the shade; press the button on the shade handle, and guide the rail to desired position. Release the button to lock the shade into place.

The shade will hold any position when the button is released. Raise the shade slowly and steadily to allow the shade to stack evenly.

CORDLESS THREE-ON-ONE SIZE STANDARDS*

Minimum Width (per panel)	16"
Minimum Width (Overall)	48"
Maximum Width (per panel)	120"
Maximum Width (Overall)	174"
Minimum Height	12"
Maximum Height	84"
Maximum Area (per panel) (Sq/Ft)	70

*Three-On-One head rail is not available in Top Down-Bottom Up



Prelude Cellular 3/4" & 2"

7.4V RECHARGEABLE SIMPLICITY MOTORIZED HARDWARE SYSTEM

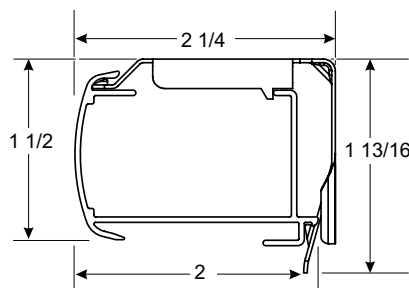

Rechargeable Simplicity Rail Dimensions

- Depth of rail: 2"
- Depth of rail and bracket: 2 1/4"
- Height of rail: 1 1/2"
- Height of bracket: 1 13/16"

Hardware Features		
Hardware colors for Prelude	Color coordinated head, bottom rails and end caps	
Standard Hardware for all Custom Graphics	White head and bottom rails and end caps	
Upgrades		
Fabric Wrapped Upgrade	Fabric used is same fabric as the shade. Back of rail is white to outside. End caps on fabric wrapped head and bottom rails are color coordinated	
Designer Metallic Upgrade	<ul style="list-style-type: none"> • Smooth faced Oil Rubbed Bronze head, bottom rails and end caps • 	
Mounting Dimensions		
Rechargeable Simplicity Motorization Hardware System		
	3/4" Prelude	2" Prelude
Minimum Shallow Mount	1/2"	3/4"
Minimum Flush Inside Mount	2 1/4"	2 1/8"
Minimum Outside Mount	7/8"	1 1/2"
Minimum Side Mount	1 1/4"	1 1/4"
Minimum Flush Side Mount	2 1/4"	2 1/4"
Recommended Side Mounting Method	<ul style="list-style-type: none"> • See page 25 for recommended mounting method for side mount shades • Width limit for side mount brackets is 36" 	
Finished Dimensions		
Inside Mount	3/4" Prelude	2" Prelude
	<ul style="list-style-type: none"> • Fabric will measure ordered width less: 3/8" • Head rail* will measure ordered width less: 1/4" • Length will measure ordered length 	<ul style="list-style-type: none"> • Fabric will measure ordered width less: 3/8" • Head rail* will measure ordered width less: 1/4" • Length will measure ordered length
Outside Mount		
	<ul style="list-style-type: none"> • Fabric will measure ordered width less: 1/8" • Head rail* will measure ordered width • Length will measure ordered length 	<ul style="list-style-type: none"> • Fabric will measure ordered width less: 1/8" • Head rail* will measure ordered width • Length will measure ordered length
Side Mount		
	<ul style="list-style-type: none"> • Fabric will measure ordered width less: 5/8" • Head rail* will measure ordered width less: 1/2" 	<ul style="list-style-type: none"> • Fabric will measure ordered width less: 5/8" • Head rail* will measure ordered width less: 1/2"

Prelude Cellular

7.4V RECHARGEABLE SIMPLICITY MOTORIZED HARDWARE SYSTEM

Rechargeable Simplicity Motors

The Simplicity Motor program features a battery powered motor utilizing a rechargeable battery hidden inside the shade head rail. Simplicity motors are compact and use a radio frequency remote to raise or lower the shades.

Rechargeable Motorized Lift Systems are not offered on sizes within the shaded area on the Standard Rectangular price grids.

Applications

- Standard Rectangular
- Top Down-Bottom Up
- Two-On-One Head Rail Bottom Up
- Two-On-One Head Rail Top Down-Bottom Up

Rechargeable Simplicity Motorization Surcharges

The Rechargeable Simplicity Motorized Lift System surcharge includes a rechargeable battery. Remotes are needed to operate the shades. Refer to pricing pages.

Important Simplicity Motorized Shade Operating and Installation Information

- Simplicity Motorized Shades installed into windows with metal casings may have a reduced radio frequency range, or may not operate at all, depending on the application.
- Do not let the antenna on the motor touch any metal objects. This may interfere with signals from the remote control.

Simplicity Rechargeable Battery

The rechargeable battery is concealed in the head rail of the shade. A charger is required for the rechargeable battery. The rechargeable battery comes fully charged from the factory.

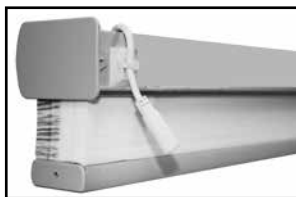

Charging Port on Back of Head rail.

RECHARGEABLE SIMPLICITY PRICING EXAMPLE:	
Prelude	
Light Filtering 42" x 60" Shade:	\$333.00
Simplicity Rechargeable Surcharge:	\$300.00
Charger for Rechargeable :	\$30.00
14 Channel Remote Control:	\$50.00
Total List Price:	\$713.00

Solar Panel Recharge Option

Plugs in to any Simplicity Rechargeable Remote control shade (does not work with PowerTouch)

Provides constant trickle charge to 7.4v Li-Ion Rechargeable battery packs. Will prolong the life of the charge of the 7.4v rechargeable battery packs, and in some applications will maintain charge indefinitely.

Life of charge is subject to application variables such as, size and weight of shade, frequency of use, amount of direct sunlight exposure, etc.



Dimensions of panel
18½" x 1½"

- Solar Panel with Mounting Brackets: \$120.00

Solar Recharge Optimum Application

- Full direct sunlight (minimum 2 hours per day) to maintain full charge. Based on one operation cycle per day (one open, one close).
- Excessive duration of cloudy weather will impact the rate of charge.
- Avoid any obstructions including mullions and screens.

Solar Panel Mounting

Bottom portion of the bracket may be lowered if needed for more sun exposure. Bracket can be mounted behind or next to shade mounting bracket.

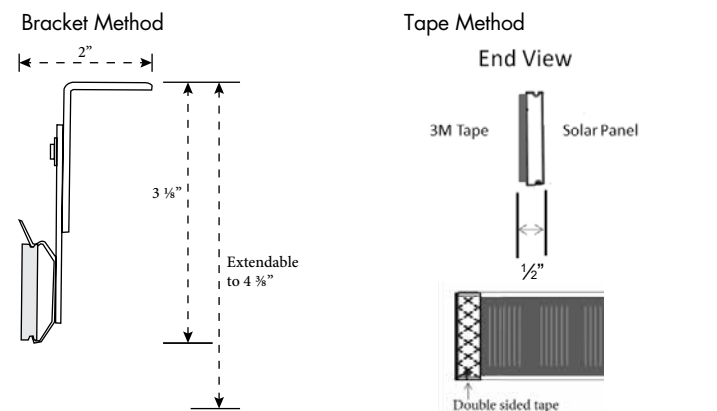

If the solar panel is mounted directly behind the headrail at the top of the window, you need to make sure that the solar panel does not interfere with the shade mounting brackets also. The solar panel can go between brackets spaced apart, or behind brackets if the depth of the window casing allows.

Prelude Cellular

7.4V RECHARGEABLE SIMPLICITY MOTORIZED HARDWARE SYSTEM

Simplicity Rechargeable Battery Life

Rechargeable batteries are included with the motor.

The average battery charge will last 6-12 months based on an average sized shade raised and lowered once per day. The life of the battery charge will vary based on the type of window covering selected, the size and weight of the window covering and the number of times the shade is operated on a daily basis.

The battery can be recharged up to 500 times. It takes approximately 5 hours to recharge the motor when fully depleted.

Ordering Information for Rechargeable Motorized Cellular Shades

Simplicity Motor Option

- Specify IB or OB mount and rail color.
- Specify remote and other accessories if needed.
- Specify one or more battery chargers.

Please Note:

- Not all motors run at the same rate of speed.
- Simplicity motors have a "Favorites" position setting. If the homeowner wants to set several shades at the same intermediate position, follow instructions provided with installation manual.
- Simplicity Rechargeable Motorized Cellular Shades are programmed at the factory with the "up and down" limits. The shades are **UNLINKED** from the remote so they are not able to operate during shipping. Each shade should be installed **after** linking it to the remote.
- **REMEMBER: Order at least one charger if ordering rechargeable motors.**

Simplicity Motorized Shade Warranty

Please see Policy PDF for complete Comfortex warranty information.

Battery Charger

8.4 Volt charger requires a standard power outlet to recharge the battery. You must specify charger when ordering a Simplicity Rechargeable Shade. The charger plugs into the charger port. The charger is black and comes with a 156" wire. The dimensions are 1" wide x 2½" length x 1¾" deep.



Top Down-Bottom Up Simplicity Motor Hand Held 14 Channel Remote

The TDBU remote has 14-channels. Each channel has a setting able to operate the middle rail and a setting able to operate the bottom rail. The TDBU remote is required for TDBU motors, but can be used with other motors as well. The **14 Channel TDBU remote** can operate up to fourteen shades individually or 14 groups. Simplicity Rechargeable Motorized Cellular Shades are programmed at the factory with the "up and down" limits. The shades are **UNLINKED** from the remote so they are not able to operate during shipping. Each shade should be installed **after** linking it to the remote.



Simplicity TDBU remotes and holders are white in color. The remote comes with a holder which can be mounted to a wall for easy storage. The range of the remote is approximately 80 feet. A **14 Channel (14C) remote** can be utilized on all Simplicity motorized shades.

Simplicity Motor Hand Held Remotes Operation

Press the up or down button on the remote to raise or lower the shade to your desired position.

To reprogram channel assignments, please refer to the installation instructions and/or view the video at: comfortex.com/comfortex-dealers.

The Simplicity remotes utilize one 3V battery. Batteries are included. Comfortex will warranty batteries for up to 3 months from date of purchase. Batteries are not covered by the warranty.

Prelude Cellular

7.4V RECHARGEABLE MOTORIZED TOP DOWN-BOTTOM UP HARDWARE SYSTEM

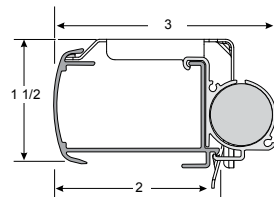
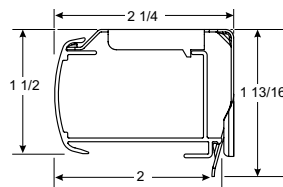
**Simplicity Motorized Rail Dimensions**

- Depth of rail: 2"
- Depth of rail and bracket: 2 1/4"
- Height of rail: 1 1/2"
- Height of bracket: 1 13/16"

Simplicity Motorized Rail with External Battery Dimensions (shades under 36")

- Depth of rail: 2"
- Depth of rail, bracket & battery: 3"
- Height of rail: 1 1/2"
- Height of bracket: 1 13/16"

Hardware Features	
Standard Hardware	• Color coordinated head, middle, and bottom rails. End Caps will be color coordinated.
14 Channel TDBU Remote	Upper and lower limit stops pre-programmed
Upgrades	
Designer Metallic Upgrade	• Smooth faced Designer Oil Rubbed Bronze head, middle, bottom rails and end caps
Fabric Wrapped Rails	• Fabric used to cover the rails is the same fabric as the shade. The back of the rail will be white to the outside. End Caps will be color coordinated.
Mounting Dimensions	
Simplicity Motorized Hardware System	
Minimum Shallow Mount	1/2"
Minimum Flush Inside Mount	2 1/4"
Minimum Outside Mount	7/8"
Minimum Side Mount	1 1/4"
Recommended Side Mounting Method	<ul style="list-style-type: none"> • See page 25 for recommended mounting method for side mount shades • Width limit for side mount brackets is 36"
Finished Dimensions	
Inside Mount	
	<ul style="list-style-type: none"> • Fabric will measure ordered width less: 3/8" • Head rail* will measure ordered width less: 3/16"
Outside Mount	
	<ul style="list-style-type: none"> • Fabric will measure ordered width • Head rail* will measure ordered width plus: 3/16"
Side Mount	
	<ul style="list-style-type: none"> • Fabric will measure ordered width less: 7/8" • Head rail* will measure ordered width less: 1 1/16"
Exact (End Cap to End Cap) Mount	
	<ul style="list-style-type: none"> • Fabric will measure ordered width less: 3/16" • Head rail* will measure ordered width
* Head rail measurements include endcaps. Width and length measurements may vary +/- 1/8"	

Prelude Cellular

7.4V RECHARGEABLE MOTORIZED TOP DOWN-BOTTOM UP HARDWARE SYSTEM

Rechargeable Simplicity Motors

The Simplicity TDBU Motor program features a battery powered motor utilizing a rechargeable battery hidden inside the shade head rail. If shades are less than 36" in width, an external snap-on battery pack is necessary.

(See picture to right)

Applications

- TDBU Rectangular/ Two-On-One Head Rail

Rechargeable Simplicity Motorization Surcharges

The Rechargeable Simplicity Motorized Lift System surcharge includes a rechargeable battery. Remotes are needed to operate the shades. Refer to pricing pages.

Ordering Information for Top Down-Bottom Up Motorized Cellular Shades

Simplicity Motor Option

- Specify IB or OB mount and rail color.
- 14 Channel TDBU Remote is required.
- Specify one or more battery chargers.

Please Note:

- Shades that are 24"-36" in width will have an external battery.
- Shades with an external battery and OB mounted will need spacer blocks.
- Simplicity Rechargeable Motorized Cellular Shades are programmed at the factory with the "up and down" limits.
- **REMEMBER: Order at least one charger if ordering rechargeable motors.**

Top Down-Bottom Up Simplicity Motor Hand Held 14 Channel Remote

The TDBU remote has 14-channels. Each channel has a setting able to operate the middle rail and a setting able to operate the bottom rail. The TDBU remote is required for TDBU motors, but can be used with other motors as well. The **14 Channel TDBU remote** can operate up to fourteen shades individually or 14 groups. Simplicity Rechargeable Motorized Cellular Shades are programmed at the factory with the "up and down" limits. The shades are **UNLINKED** from the remote so they are not able to operate during shipping. Each shade should be installed **after** linking it to the remote.

Simplicity TDBU remotes and holders are white in color. The remote comes with a holder which can be mounted to a wall for easy storage. The range of the remote is approximately 80 feet. A **14 Channel (14C) remote** can be utilized on all Simplicity motorized shades.



Simplicity Rechargeable Battery for TDBU

The rechargeable battery is concealed in the head rail of the shade. A charger is required for the rechargeable battery. The rechargeable battery comes fully charged from the factory.

Rechargeable Battery Pack is concealed in the head rail. Minimum width of 36" is required otherwise battery wand must be mounted externally.

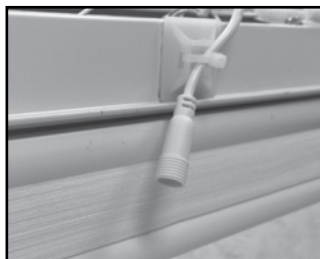

Charging Port on Back of Head rail.

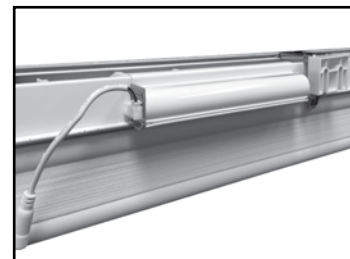

Snap-On external battery for TDBU shades 36" or less in width. Spacer block also required for outside mount.

Battery Charger

8.4 Volt charger requires a standard power outlet to recharge the battery. You must specify charger when ordering a Simplicity Rechargeable Shade. The charger plugs into the charger port. The charger is black and comes with a 156" wire. The dimensions are 1" wide x 2 1/2" length x 1 3/4" deep.

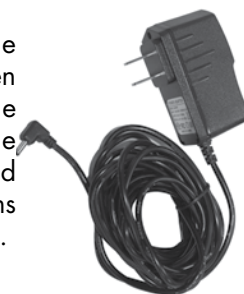

Solar Panel Recharge Option

Plugs in to any Simplicity Rechargeable Remote control shade (does not work with PowerTouch). See page 33.



Dimensions of panel 18 1/2" x 1 1/2"

PRELUDE MOTORIZED TOP DOWN-BOTTOM UP PRICING EXAMPLE:

Prelude	
Light Filtering 42" x 60" Shade:	\$333.00
Simplicity Rechargeable TDBU Surcharge:	\$515.00
Charger for Rechargeable:	\$30.00
TDBU Remote Control:	\$50.00
Total List Price:	\$928.00

Prelude Cellular $\frac{3}{4}$ " & $1\frac{1}{4}$ "

7.4V RECHARGEABLE POWERTOCH MOTORIZED HARDWARE SYSTEM

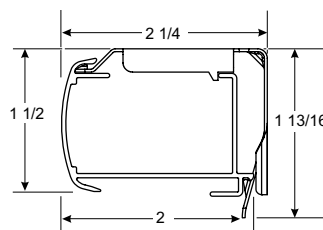

$1\frac{1}{4}$ " Pleat fabric Rail Profile not available at time of printing. Please refer to online price list

Simplicity Motorized Rail Dimensions

- Depth of rail: 2"
- Depth of rail and bracket: $2\frac{1}{4}$ "
- Height of rail: $1\frac{1}{2}$ "
- Height of bracket: $1\frac{13}{16}$ "

 $1\frac{1}{4}$ " Pleat Fabric Rail Dimensions

- Depth of rail: NA
- Depth of rail and bracket: NA
- Height of rail: NA
- Height of bracket: NA

Hardware Features

Hardware colors for all Cellular and Pleated fabrics	Color coordinated head, bottom rails and end caps
Standard Hardware for all Custom Graphics	White head and bottom rails and end caps
PowerTouch Wand	Upper and lower limit stops pre-programmed, Intermediate stop "favorites" position available

Upgrades

Fabric Wrapped Upgrade	Fabric used is same fabric as the shade. Back of rail is white to outside. End caps on fabric wrapped head and bottom rails are color coordinated
Designer Metallic Upgrade	<ul style="list-style-type: none"> • Smooth faced Oil Rubbed Bronze head, bottom rails and end caps

Mounting Dimensions**Simplicity Motorized Hardware System**

Minimum Shallow Mount	$\frac{1}{2}$ "
Minimum Flush Inside Mount	$2\frac{1}{4}$ "
Minimum Outside Mount	$\frac{7}{8}$ "
Minimum Side Mount	$1\frac{1}{4}$ "
Minimum Flush Side Mount	$2\frac{1}{4}$ "
Recommended Side Mounting Method	<ul style="list-style-type: none"> • See page 25 for recommended mounting method for side mount shades • Width limit for side mount brackets is 36"

Finished Dimensions**Inside Mount**

	<ul style="list-style-type: none"> • Fabric will measure ordered width less: $\frac{3}{8}$" • Head rail* will measure ordered width less: $\frac{3}{16}$"
--	---

Outside Mount

	<ul style="list-style-type: none"> • Fabric will measure ordered width • Head rail* will measure ordered width plus: $\frac{3}{16}$"
--	---

Side Mount

	<ul style="list-style-type: none"> • Fabric will measure ordered width less: $\frac{7}{8}$" • Head rail* will measure ordered width less: $1\frac{1}{16}$"
--	--

Exact (End Cap to End Cap) Mount

	<ul style="list-style-type: none"> • Fabric will measure ordered width less: $\frac{3}{16}$" • Head rail* will measure ordered width
--	---

* Head rail measurements include endcaps. Width and length measurements may vary +/- $\frac{1}{8}$ "

Prelude Cellular

7.4V RECHARGEABLE POWERTOCH MOTORIZED HARDWARE SYSTEM

PowerTouch™ Rechargeable Shades

Cellular Shades can be fabricated with the PowerTouch Rechargeable Push Button Control option. The PowerTouch Rechargeable option is an easy, cord free motorized operation for the budget savvy homeowner. PowerTouch Rechargeable uses Simplicity motors and components.

PowerTouch Rechargeable Shades Operation

Press the up or down button on the pendant to raise or lower the shade to your desired position.

No programming is required with PowerTouch™, all programming is set at the factory. Upper and lower limits can easily be adjusted in the field if desired. Please refer to the installation instructions at comfortex.com/ comfortex-dealers.com/. A "favorites" or intermediate stop position can be set once installed.

PowerTouch Rechargeable Surcharges

See page 11.

PowerTouch Appearance

- The PowerTouch wand and pendant is attached to the head rail when installed.
- The wand and pendant hangs down the front of the shades from the head rail. The wand does not touch the fabric.
- Pendant is 2½" long.
- The pendant does not need to be mounted to the wall to operate the shade.



PowerTouch Rechargeable Color Options

- Shades with Black or Oil Rubbed Bronze hardware will be built with black wand and pendants standard. All other colors will use white wand and pendants.



White



Black Shown with Plug-In Charger

PowerTouch Wand and Pendant Location

The standard location for the wand and pendant is on the right. Please specify location when ordering.

PowerTouch Rechargeable Wand Length

- The standard length of the wand will measure the indicated below unless otherwise specified.

Shading Length	Standard Wand Length
Up to 30"	1' (12")
>30" to 52"	2' (24")
>52" to 78"	3' (36")
>78" to 100"	4' (48")
>100" to 120"	5' (60")

Mounting Requirements for PowerTouch Rechargeable Shades

- No special installation hardware or wiring requirements are needed.

Battery Charger

8.4 Volt charger requires a standard power outlet to recharge the battery. You must specify charger when ordering a Simplicity Rechargeable Shade. The charger plugs into the charger port. The charger is black and comes with a 156" wire. The dimensions are 1" wide x 2½" length x 1¾" deep.



PowerTouch Rechargeable Shades Warranty

Please see Policy PDF for complete warranty information.

PRELUDE MOTORIZED 2-ON-1 PRICING EXAMPLE:

Prelude		
Light Filtering 42" x 60" Shade:		\$333.00
	x2:	\$666.00
2-on-1 Surcharge:		\$66.00
7.4V PowerTouch:		\$100.00
	x2:	\$200.00
Charger for Rechargeable:		\$30.00
Total List Price:		\$962.00

Cellular Shade Collection

7.4V RECHARGEABLE SIMPLICITY HARDWARE SYSTEM

EZ Charge Extension Wand Option

EZ Charge Extension Wand is the newest innovation in rechargeable motorization. Easily charge your hard to reach Simplicity Rechargeable Shades with the EZ Charge Extension Wand to charge. The wand extends up to 31" in length.

Simple to use! Place the magnetized wand tip to the receiving port to attach. Then plug the charger into the base of the wand. It is that simple!

- EZ Charge Extension Wand can be easily concealed by a valance or drapery panel.
- Great for out of reach windows

EZ Charge Wall Mount Receiver

- The EZ Charge Wall Mount Receiver includes screws and anchors. These can be used for wood or drywall mounting.
- Extension cable plugs into charging port of Simplicity Rechargeable shades.

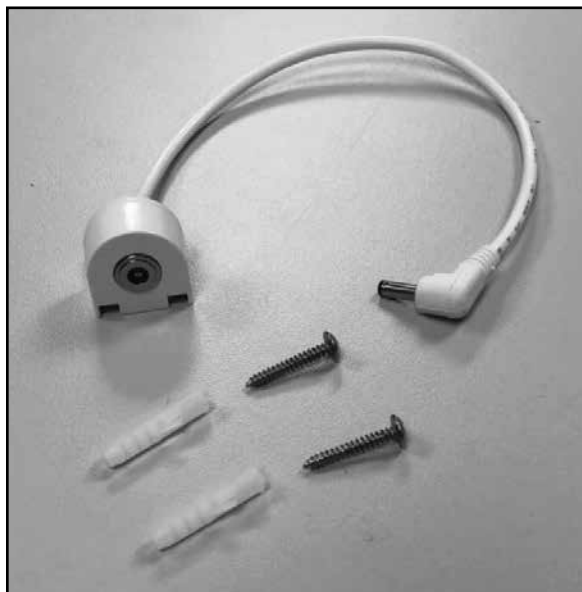

EZ Charge Wall Mount Receiver Kit | CKIT078
One kit per Simplicity Motorized shade is needed.

EZ Charge Wand

- Wand is 9 1/2" and extends to 31"
- Magnetized tip makes connection quick and easy.
- Once wand is in place plug the 8.4v charger into the bottom of the extension wand for charging.

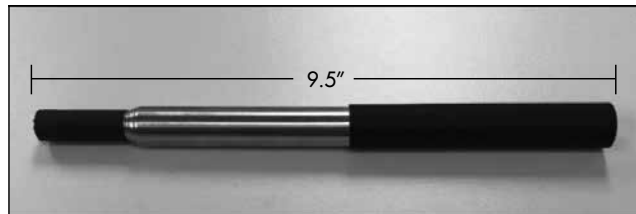

EZ Charge Wand | CKIT077
Order with the EZ Charge Wall Mount Receiver Kit



EZ Charge Receiving Port



Port/Wand Connection

Shade/Blind Product	EZ Charge Wall Mount Receiver List Price	EZ Charge Wand List Price
---------------------	--	---------------------------

Cellular	\$18	\$32
----------	------	------



Battery Charger



Wand Base

Battery Charger - SOLD SEPARATELY

You must specify charger when ordering a Simplicity Rechargeable Motorized Shade. The charger plugs into the wand base. The 8.4 Volt charger requires a standard power outlet to recharge the motor. The charger is black and comes with a 156" wire. The dimensions are 1" wide x 2 1/2" length x 1 3/4" deep.

Cellular Shade Collection

SIMPLICITY SMART CONTROLLER



Simplicity Smart Controller Dimensions

- Width of controller: 2 $\frac{3}{8}$ "
- Length of controller: 2 $\frac{15}{16}$ "
- Height of controller: 1 $\frac{1}{8}$ "

Simplicity Smart Controller

- Works with Apple and Android devices
- FREE Downloadable Application
- Compatible with previously installed Simplicity Remote Control Shades
- Powered by NEO Smart Blinds App
- Compatible with Amazon Alexa, Google Assistant systems, Control4 and Savant systems

Simplicity Smart Controller

The Simplicity Smart Controller is a small device that you install in your home that allows you to set automatic opening and closing times for all Simplicity motorized shades as well as the ability to control your motorized shades from a phone, tablet or PC from anywhere in world.

The Simplicity Smart Controller will work with any Comfortex remote motorized shade with Simplicity remote control motors purchased after 2012.

The Simplicity Smart Controller plugs into a standard electrical outlet and connects to WiFi and sends signals to your shades using the same radio frequencies as a normal remote control.

How Does The NEO Smart Blinds App Work?

The app uses WiFi or cellular data to send commands over the internet to the Simplicity Smart Controller.

Do I Need Any Other Equipment?

Yes, The location where your shades are installed must have WiFi in order for the Simplicity Smart Controller to work. Additionally, you must have a smartphone or tablet running Android or iOS (eg. iPhone, iPad, Samsung Galaxy S7) and have the NEO Smart Blinds app. installed.

Why Would I Want A Simplicity Smart Controller?

There are two main ways the Simplicity Smart Controller adds additional value to your motorized shades. First, once all of your shades have been added, you can use your smartphone as a single remote for all of your shades that will work anywhere you are regardless of distance from the shade. Secondly, the device allows you to set schedules so your motorized shades automatically open and close without needing to do anything on a day to day basis.

Do I Need To Buy More Than 1 Controller?

The normal use for the Simplicity Smart Controller is to plug it in out of the way and forget it. Since it has roughly the same range as a remote you will want enough devices to allow all shades to be operated without moving the controller. So depending on the layout of the home and location of the shade, you might want multiple devices to have convenient full home coverage.

How Far Is The Range Of A Controller?

You should see a range of approximately 150 ft. However this number might be less depending on the layout of your home. In general we recommend one per a floor of a normal sized home.

Can I Control My Shades From Multiple Devices?

Yes! You can download the NEO Smart Blinds App onto multiple devices, After installing the App. on a new device simply log in with the same email/password on each device and you will have access to control your shades.

Can It Be Used With Already Installed Shades?

Yes! Simply follow the directions in the NEO Smart Blinds app. to add a shade. At the pairing step you can put the shade in pairing mode using the primary remote control (or by accessing the button on the shades motor). Adding the shade to the NEO Smart Blinds App. will not affect the normal remote operation.

How Much Does The NEO Smart Blinds App Cost?

The App is a free download, However you must have at least one Simplicity Smart Controller to serve as a bridge between the App and your shades.

Prelude Cellular

OVATION CELLULAR SLIDER HARDWARE SYSTEM

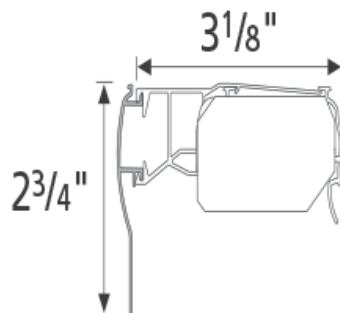

Ovation Hardware Rail Dimensions

- Depth of rail and bracket: 3 1/8"
- Valance Height: 2 3/4"
- For each spacer block 1/2" will be added to the length of the valance returns. For extension brackets, 2" will be added unless otherwise instructed.

Hardware Features	
Standard Hardware colors for Comfortex Prelude	Coordinating rail colors have been preselected for each fabric. More colorful fabrics are coordinated to white and off-white rail colors.
Ovation Valance	Every Ovation Slider comes with a painted aluminum valance. The valance attaches to the head rail using a durable plastic clip system.
Mounting Dimensions	
Minimum Inside Mount, Installation Bracket	1 5/16"
Minimum Flush Mount	3 5/8"
Minimum Outside Mount	5/8"
Mounting Specs	
	<ul style="list-style-type: none"> • For each spacer block, 1/2" will be added to the length of the valance returns. For extension brackets, 2" will be added unless otherwise instructed. • Specify Inside Mount (IB) or Outside Mount (OB) when ordering. If the slider requires a non-flush inside mount, you must order a custom valance. • Exact valance width and exact valance return length (minimum 1 1/2") must be specified in the Special Instructions section of the order form.
Finished Dimensions	
Inside Flush Mount	
Track Width:	
Right or Left Stack	3/16" less than ordered width
Split Stack	3/16" less than ordered width
Center Stack	3/16" less than ordered width
Finished Slider Length	1/2" less than ordered width
Valance	3/16" less than ordered width
Outside Mount	
Track Width	3/16" less than ordered width
Finished Slider Length	Ordered length - No reductions will be made
Valance	Ordered width plus 1"
Valance Returns	Will measure 3 1/8" (standard)

Prelude Cellular

OVATION CELLULAR SLIDER HARDWARE SYSTEM

Applications

- Standard Rectangular
- Opens and closes from side to side
- Four stacking options - see below.

Ovation Stacking Width

Width	up to 84"	up to 96"	up to 108"	up to 120"
Stack	6½"	7¼"	8"	8¾"

Minimum Ovation Stack

Ovation's fabric stack measures 6½" regardless of the ordered width. Fabric stacking dimensions are determined by the slider's hardware, not ordered width.

Things to Consider

- Since most Ovations are sold in large sizes, the shade will have a large fabric stack. On an outside mount, you may want to order the shade a few inches wider so that the fabric stack can be clear of the window.

Ordering Information for Ovation Cellular Sliders

- Specify IB or OB mount.
- Specify stacking configuration.
On Split Stack Shades, both panels will be of equal width unless specified.
- Specify valance width and return length.

Ovation Valance Specifications

- Every Ovation Slider is supplied with a painted aluminum valance.
- The valance attaches to the head rail using a durable plastic clip system.

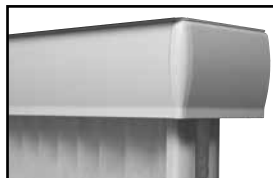

Ovation Valance Dimensions

All valance dimensions are measured on the flat, back side.

- Valance Height: 2¾"
- Standard Return Length (OB only): 3⅛"
- For each spacer block, ½" will be added to the length of the valance returns. For extension brackets, 2" will be added unless otherwise instructed.

Vertical Stacking Options

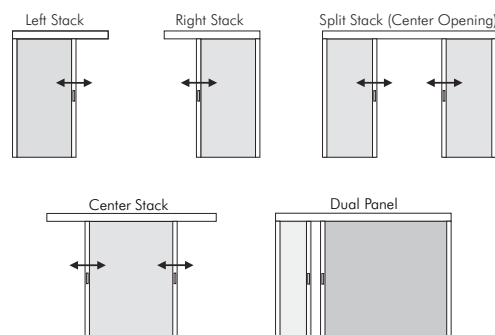

Specify stacking configuration when ordering.

Left: Fabric stacks to the left side of the slider.

Right: Fabric stacks to the right side of the slider.

Center Stack: Center Stack Sliders fabric panels can move fully to the left or the right.

Split Stack: Fabric is split in the center of the slider forming two equal panels which open to opposite ends of the slider. Both panels will be of equal width unless otherwise specified.



Prelude Cellular STARBURST ARCHES HARDWARE SYSTEM

Stationary Starburst

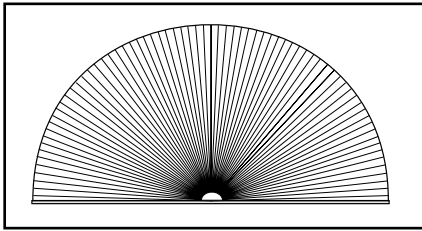

Figure A

Movable Starburst

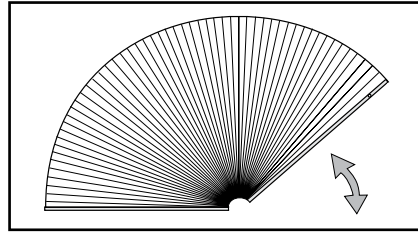

Figure B

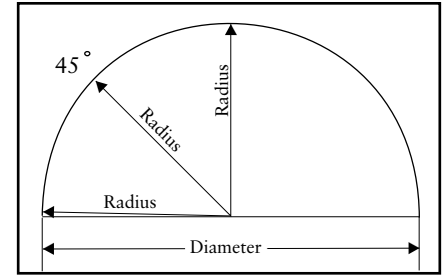

Figure C

Hardware Features	
Standard Hardware colors for Comfortex Prelude	Color coordinated rails
Mounting Dimensions	
Minimum Shallow Mount	3/4"
Minimum Flush Inside Mount	2 3/8"
Recommended Side Mounting Method	• Width limit for side mount brackets is 48"
Finished Dimensions	
Inside and Side Mount	
<ul style="list-style-type: none"> Fabric will measure ordered width less: 3/8" Head rail* will measure ordered width less: 3/16" 	<ul style="list-style-type: none"> * Head rail measurements include endcaps. Width and length measurements may vary +/- 1/8"

Applications

- Stationary Fan Style Arch
 - Movable Fan Style Arch
- Movable Starburst Arch shades are for inside and shallow mount applications only.

Stationary Starburst Features (Figure A)

- **All non-perfect Stationary Starburst arches require a template.** See page 53 to for template instructions.
- **All templates should be made from brown craft paper.** Comfortex offers template kits. Please contact Customer Service to order. Stock number: 751000
- A perfect arch is twice as wide as it is high.
- Prelude Stationary Starburst shades must have a height that equals no more than half the width.
- When ordering arches as perfect half-circles make sure the radius of the arch remains constant to ensure a proper fit. (See Figure C)

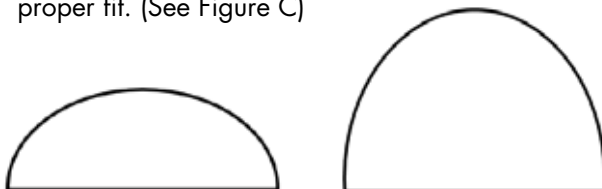

This type of shape is allowed. This type of shape is not allowed.

- Min height = 1/4 of width, Max height = 1/2 of width
- Max height of straight sides is 10". Heights must be at least 25% of total width after the straight sides.

Movable Starburst Features (Figure B)

- Starburst Movable archtop shades are cut to perfect half circles only and do not require a template. The height must be exactly 1/2 the diameter.
- A perfect arch is twice as wide as it is high.
- When ordering arches as perfect half circles make sure the radius of the arch remains constant to ensure a proper fit. (See Figure C)
- The hinge gap (gap between the two rails) is not centered in the window. The moving rail is always smaller than the stationary rail to provide proper movement within the window.

Ordering Information for Sunset Shades

- Specify IB mount and rail color.
- Include a template if the shade is a non-perfect arch.

Accessories

- 5-10' Expandable Pole - Black



Specially designed pole end fits into the handle on movable Starburst Shades for easy operation.

Prelude Cellular SUNSET ARCHES HARDWARE SYSTEM

Movable Sunset

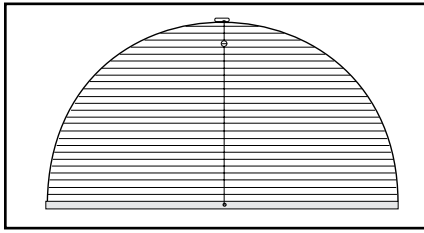

Figure A

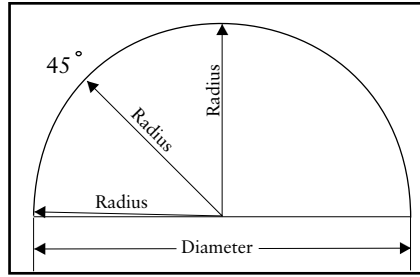

Figure B

Two-String Hanging Method

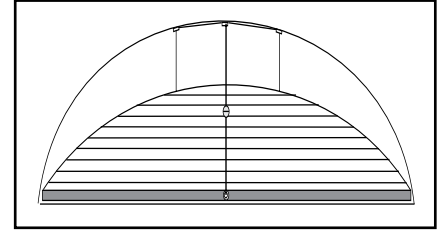

Figure C

Hardware Features | See Page 26 for Rail Dimensions

Hardware colors for all Prelude	Color coordinated head, middle and bottom rails with white cord and silver tassel
---------------------------------	---

Mounting Dimensions	Standard Rail
Minimum Shallow Mount	3/4"
Minimum Flush Inside Mount	2 3/8"
Minimum Side Mount	1 3/8"
Minimum Flush Side Mount	1 7/8"
Recommended Side Mounting Method	<ul style="list-style-type: none"> • See page 25 for recommended mounting method for side mount shades • Width limit for side mount brackets is 48"

Finished Dimensions

Inside and Side Mount

- Fabric will measure ordered width less: 3/8"
- Head rail* will measure ordered width less: 3/16"

Outside Mount

- Is not offered for Prelude Sunset Top-Down Arches

* Head rail measurements include endcaps.
 Width and length measurements may vary +/- 1/8"

Applications

- Movable Arch

Ordering Information for Sunset Shades

- Include a template if the shade is a non-perfect arch.

Accessories

- 3' Expandable Pole - Silver



- 5-10' Expandable Pole - Black



Specially designed pole end fits into the ball on Sunset Shades for easy operation.

Prelude Cellular SUNSET ARCHES HARDWARE SYSTEM

Sunset Features and Ordering Notes (Figure A)

- Sunset shades have horizontal pleats that stack at the bottom, on a stationary sill rail. Sunset shades are operated by a continuous cord that runs through a top mount guide block and back down through the stationary rail. A moving metal ball attached to the cord is used to raise and lower the shade. (See Figure D).
- **All Sunset arches require a template.** A perfect arch is twice as wide as it is high. See page 53 **All templates should be made from brown craft paper.** Comfortex offers template kits. Please contact Customer Service to order. Stock number: 751000
- Sunset shades which are not perfect half circles must have a height which is equal to or greater than 25% of the width.
- When ordering Sunset shades that are perfect half circles, make sure the radius of the arch remains constant to ensure a proper fit. (See Figure B).
- **Stringing Method:** Depending on the curvature of a particular arch, it may be necessary to use the two string method (See Figure C) to ensure proper fit and operation of your Sunset shade. Comfortex will determine the best stringing method after examination of the template.

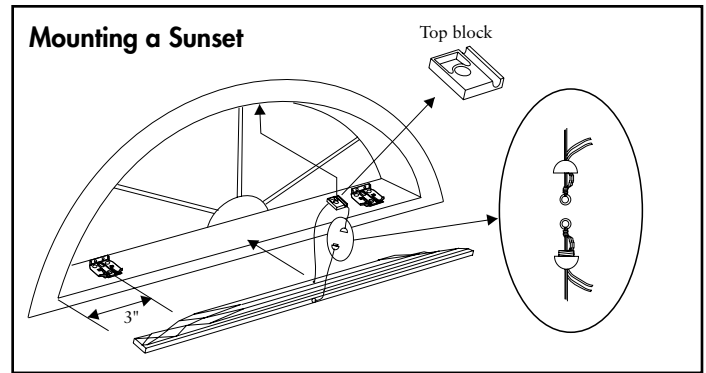

Figure D

Recommended Mounting Method for Side Mounting Shades

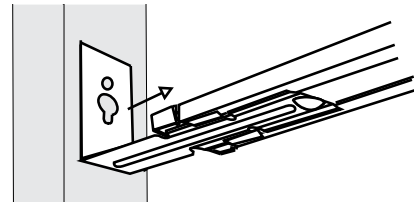

Figure F

Refer to the installation instructions on Comfortexdealers.com or the OnDemand Mobile Library for further details on side mounting shades.



Prelude Cellular QUARTER ROUNDS HARDWARE SYSTEM

Stationary Quarter Round

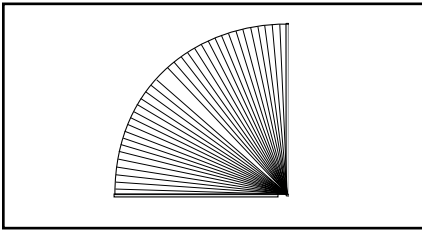

Figure A

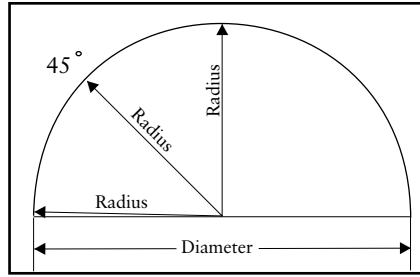

Figure B

Hardware Features	
Hardware colors for all Cellular and Pleated fabrics	Color coordinated rails
Mounting Dimensions	
Minimum Shallow Mount	3/4"
Minimum Flush Inside Mount	2 3/8"
Minimum Outside Mount	3/4"
Minimum Side Mount	1 3/8"
Minimum Flush Side Mount	1 7/8"
Recommended Side Mounting Method	<ul style="list-style-type: none"> • See page 45 for recommended mounting method for side mount shades • Width limit for side mount brackets is 48"
Finished Dimensions	
Inside and Side Mount	
	<ul style="list-style-type: none"> • Fabric will measure ordered width less: 3/8" • Head rail* will measure ordered width less: 3/16"
Outside Mount	
	<ul style="list-style-type: none"> • Fabric will measure ordered width • Head rail* will measure ordered width plus: 3/16"
Exact (End Cap to End Cap) Mount	
	<ul style="list-style-type: none"> • Fabric will measure ordered width less: 3/16" • Head rail* will measure ordered width
* Head rail measurements include endcaps. Width and length measurements may vary +/- 1/8"	

Applications

- Stationary Fan Style Quarter Round

Ordering Information for Quarter Rounds Shades

- Specify IB or OB mount and rail color.

Quarter Rounds Features

- Price according to the largest radius measurement.
- **All templates should be made from brown craft paper.** Comfortex offers template kits. Please contact Customer Service to order. Stock number: 751000
- When ordering arches as perfect quarter circles, make sure the radius of the arch remains constant to ensure a proper fit. (See Figure B)

Prelude Cellular TRAPEZOIDS HARDWARE SYSTEM

Movable Trapezoids

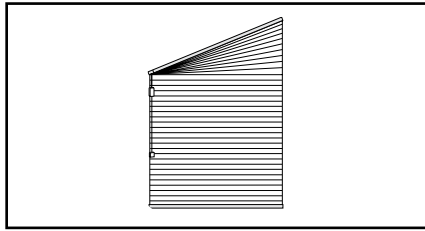

Hardware Features See Page 26 for Rail Dimensions	
Standard Hardware colors for Comfortex Prelude	Color coordinated head and bottom rails with white cord and tassel
Mounting Dimensions	
Minimum Shallow Mount	3/4"
Minimum Flush Inside Mount	2 3/8"
Minimum Outside Mount	3/4"
Minimum Side Mount	1 3/8"
Minimum Flush Side Mount	1 7/8"
Recommended Side Mounting Method	<ul style="list-style-type: none"> • See page 45 for recommended mounting method for side mount shades • Width limit for side mount brackets is 48"
Finished Dimensions	
Inside and Side Mount	
	<ul style="list-style-type: none"> • Fabric will measure ordered width less: 3/8" • Head rail* will measure ordered width less: 3/16"
Outside Mount	
	<ul style="list-style-type: none"> • Fabric will measure ordered width • Head rail* will measure ordered width plus: 3/16"
Exact (End Cap to End Cap) Mount	
	<ul style="list-style-type: none"> • Fabric will measure ordered width less: 3/16" • Head rail* will measure ordered width
* Head rail measurements include endcaps. Width and length measurements may vary +/- 1/8"	

Applications

- Movable Trapezoids
- Movable Octagons

Ordering Information for Trapezoid Shades

- Specify IB or OB mount and rail color.
- **Trapezoid orders must be faxed in with a diagram. Please provide measurements for all four sides when ordering.**

Ordering Information for Octagon Shades

- Specify IB or OB mount and rail color.
- **The width, length and one side are required measurements when ordering.**

Prelude Cellular

TRAPEZOIDS AND OCTAGONS HARDWARE SYSTEM

Trapezoids (Figure A)

- Trapezoid orders must be faxed in with a diagram. Please provide measurements for all four sides when ordering. Template is required.
- The maximum slope of the top rail is 30 degrees from horizontal. Slope is the angle between slope and a horizontal line. The slope angle must be measured with a protractor.
- Sides of trapezoid must be parallel.
- Sill must be level for proper installation and operation of a trapezoid shade.
- Operating cord must be placed on the short side.
- See Figure B for trapezoid shade operation.

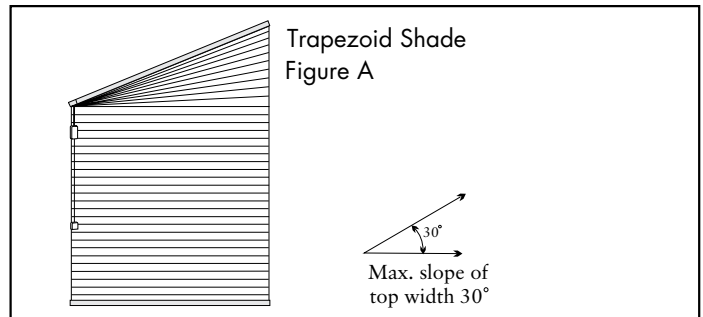

Trapezoid Shade Operation

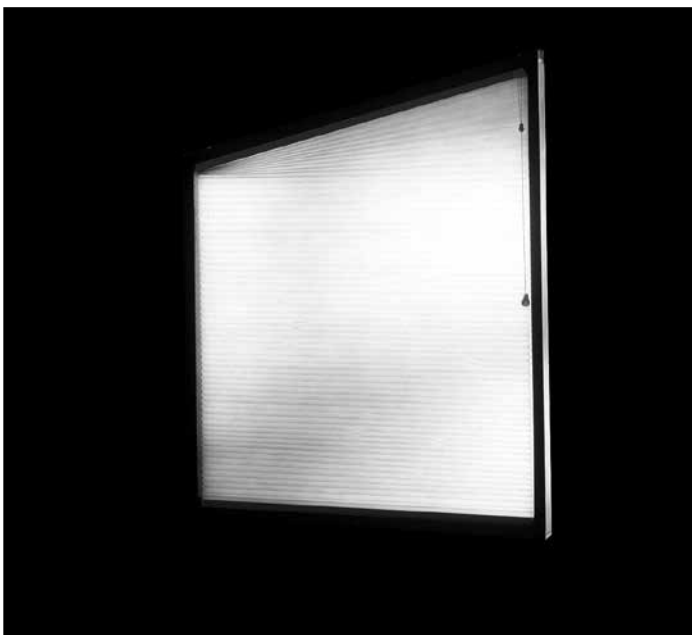
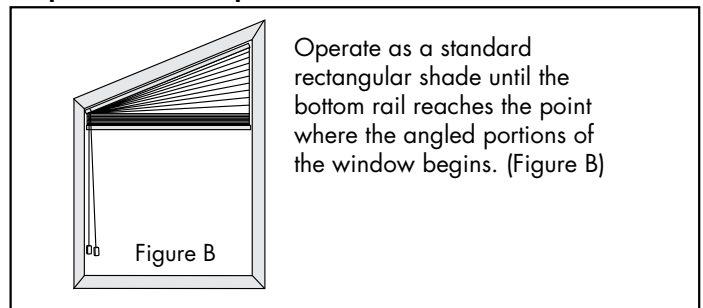

Prelude Cellular SKYLIGHT SHADING HARDWARE SYSTEM

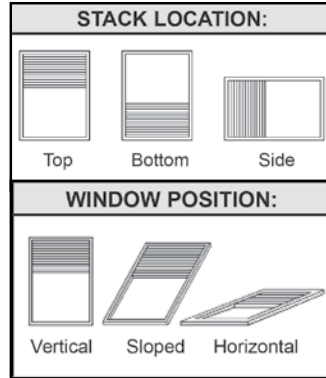
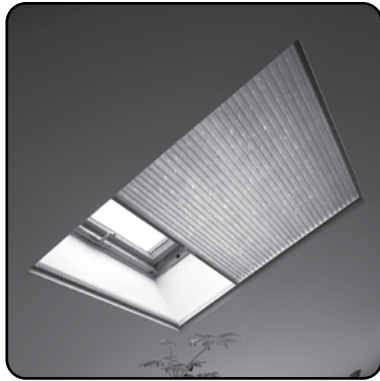

Skylight Vertical Applications

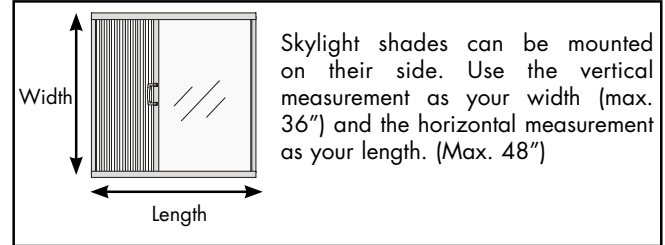

Figure A

Hardware Features	
Standard Hardware colors for Comfortex Prelude	White head and bottom rails with white cord in a white sidetrack.
Upgrades	
Fabric Wrapped Upgrade	Not Available
Designer Metallic Upgrade	Not Available
Mounting Dimensions - Inside Only	
Skylight Shading System	
Minimum required for installation	1 1/4"
Minimum Flush Inside Mount (Rail Fully Recessed)	2 1/2"
The widest width of the window cannot exceed the narrowest width of the window by more than 3/8".	
Finished Dimensions	
Inside Mount	
	<ul style="list-style-type: none"> Fabric will measure ordered width less: 3/4" Head rail* will measure ordered width less: 3/16"
* Head rail measurements include endcaps. Width and length measurements may vary +/- 1/8"	

Applications

- Horizontal, Angled and Vertical rectangular windows and skylights. Skylight Shading Systems are for inside mount applications only.

Ordering Information for Skylight Shading System

- Specify when ordering: Application angle: Angled, Horizontal or Vertical.

Accessories

- 3' Expandable Pole - Silver
(Must be ordered separately, ships from New York)



Specially designed pole end fits into the handle of Skylight shades for easy operation at any angle.

Skylight Shading System Features

- Shades can be mounted on their side. (See Figure A). Use the vertical measurement as your width (max. 36") and the horizontal measurement as your length (max. 48").
- Track system provides superior insulation and light blocking. The enclosed sides provide full privacy.
- Shades over 30" wide require support cords.
- Fabric gasket attached to moving rail to eliminate light leakage when shade is closed.



Cleaning & Care



Making A Template/Cut-outs



Measuring



Child Safety

Cellular Shades

CLEANING AND CARE

While beautiful and pleasing to the eye, all Comfortex products are designed to be durable, easily cared for and easily cleaned. Our non-woven fabrics are inherently anti-static and repel dust, but occasional feather dusting or vacuuming may be necessary to keep the fabrics clean and bright. Comfortex Cellular fabrics may be ultrasonically cleaned.

Cleaning Prelude Fabrics:

Our light filtering and room darkening fabrics are inherently anti-static and repel dust, but occasional cleaning may be necessary to keep the fabrics clean and bright. The fabric can be dusted with a soft, clean cloth, feather duster or lightly vacuumed with a soft brush attachment. Spills and stains can be lightly blotted with a cloth or damp sponge. More difficult stains may require soaking in water with mild soap. For this, remove the shades from the window and soak in warm water. Complete immersion of hardware is not recommended.

DO NOT submerge the Cordless Ultra head rail in water. When damp, lay flat to dry or place back in window and raise tightly to recrisp pleats. Please test any stronger cleaners on an unobtrusive portion of the shade before using.

For additional advice on care or cleaning, please contact our Technical Services Department.

- of lukewarm water. Dampen a clean white cloth and gently blot the stain.
- Do not overwet the fabric or excessively rub the stained area.
- See the Installation and Care instructions for complete details.

Cellular Shade Collection

GENERAL INFORMATION

Cellular Shade

MEASURING INSTRUCTIONS

Comfortex accepts measurements down to $\frac{1}{16}$ " increments.

Inside Mount

Use a steel tape to measure the opening at three different places, and use the narrowest dimension when ordering. Be exact! The factory will make the shade $\frac{3}{16}$ " narrower so it will not rub against the window casing. Measure the height of the window from the top (soffit) down to the sill.

Outside or Ceiling Mount

Use a steel tape to measure the exact height and width of the area to be covered. It is recommended that the shades overlap the window by at least $1\frac{1}{2}$ " on each side. When installation has no sill, allow the shade to overlap the bottom of the window casing by at least $1\frac{1}{2}$ ". Shade fabric will measure width indicated on the order form.

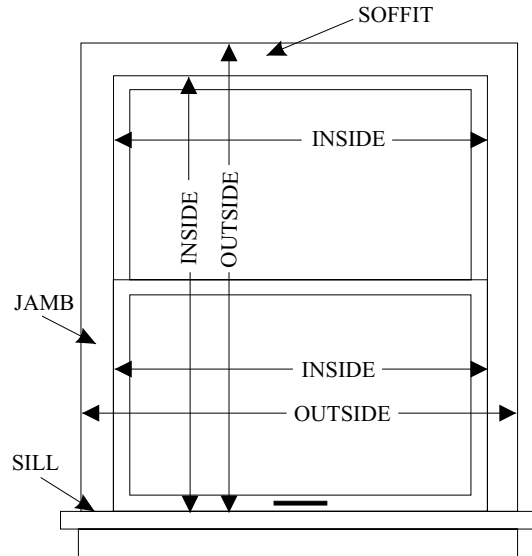

Measuring for Specialty Shapes

Templates are required with some specialty shade orders. Consult the individual product sections of this guide for specifics regarding accurate measurements and mounting information.

Arches and Quarter Round Circles

- Measure the window height and width appropriately for an inside or outside mount.
- With perfect arches, the height will be one half the width. With perfect quarter rounds, height will equal width. If the arch or quarter round is perfect, **a template is not required.**
- Windows with imperfect arch measurements do not maintain the height/width relationship. Templates **are required** for these windows.

Trapezoids

- Measure the window height and width appropriately for an inside or outside mount. For outside mounts, remember to add the desired amount of overlap.
- Measure all four sides for accurate fabrication. Provide all measurements. **Templates are not required.**
- The slope angle must be measured with a protractor. Slope is the angle between slope and a horizontal line. The maximum slope is 30 degrees.

Octagons

- Measure the window height and width appropriately for an inside or outside mount. Be sure to measure the width at the shade's widest point.
- Provide the width, length and the length of one side when ordering.

Cellular Shade Collection

GENERAL INFORMATION

Making the Perfect Template

Tape brown craft paper over the window opening. Be sure to allow plenty of overlap and check to see that the paper is smooth and pulled taut. Do not use newspaper as the ink can rub off on fabric. Do not use paper that has been folded. Notice the outline of the framework superimposed on the template as the light filters through the window. You may create the template in one of two ways:

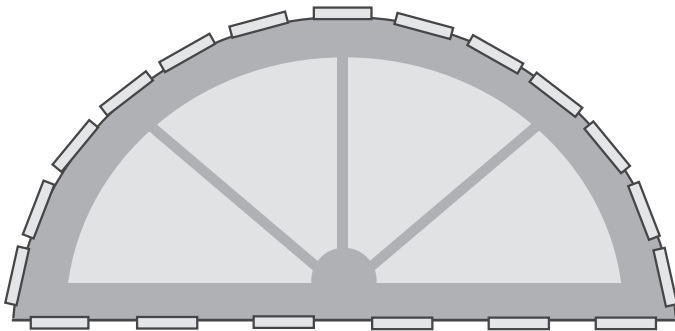

Trace the outline of the window with a pencil and continue along the side of the window frame. Once the window is completely traced, remove the craft paper from the window. Cut out the traced shape with a pair of scissors.

You may choose to skip tracing the window outline with a pencil and cut out the shape immediately with a razor knife.

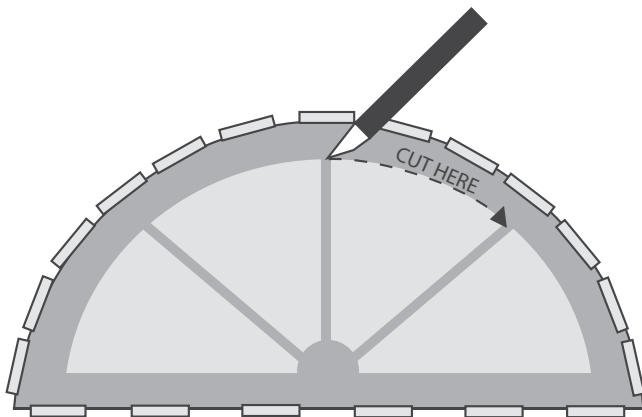

Once your template is cut, double check its width and height with your initial measurements. Test the template by placing it in the window. Check for light gaps, uneven cutting of curves etc. Trim or remake if necessary.

With arch top shades, fold the template in half. Check the outline of the curve for smoothness, light gaps and curve continuity. Place the template in the window and check it for light gaps or uneven cutting of curve. Trim or remake it if necessary.

On the front of the template, mark the shade measurements along with your company name, account number, sidemark, shade style and color. Be sure to indicate inside or outside mount, the room side and which ends of the template are top and bottom. Do not take any deductions on inside mount shades. The factory will make all necessary allowances for inside mounts.

Remember: The quality of the finished shades depends heavily on the quality of the template supplied. Do not hesitate to remake a template if you feel uncomfortable of the quality of your first attempt.

Template Kits: Comfortex offers template kits which includes brown craft paper, razor knife, instructions and order form. Please contact Customer Service or visit www.comfortex.com to order. Stock number: 751000

Cut-Outs

Cut-outs are available with all Prelude cellular fabrics except 2" pleat.

Available only on cordlock and cordloop Prelude shades.

Cut-outs are \$69.00 per side and are subject to approval by the Comfortex Technical Service department.

Minimum Cut-out width: $\frac{1}{8}$ "

Maximum Cut-out width: 3"

The portion of the shade above the cut-out will not stack tightly when the shade is raised.

Cellular Shade Collection

GENERAL INFORMATION

⚠️ WARNING

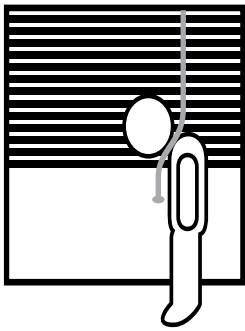

Window Blind Cord Can
STRANGLE Your Child.

To prevent strangulation, purchase
cordless products or products with
inaccessible cords.

⚠️ ADVERTENCIA

La cuerda ciega de la ventana
puede ESTRANGULAR su niño.

Para evitar el estrangulamiento,
compre alternativas inalámbricas o
productos con cables inaccesibles.

Child Safety

Comfortex has a long history of designing new child-safety products and is proud to provide a leadership role in cooperating with the Consumer Product Safety Commission (CPSC) for the development of policies and guidelines for the industry by serving on the WCMA Standards Development Committee.

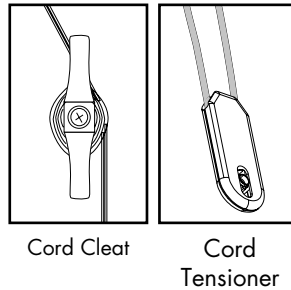

Cord Cleat

Cord
Tensioner

All Comfortex products have been fully tested and proven to comply with the current WCMA Standards for safety of corded window coverings.

Be aware that it is possible for children to become entangled in window covering cords. To reduce the risk of accidents, all cords must be kept out of the reach of children.

A cord cleat or cord tensioner is an effective way to implement this essential precaution. Please use them.

To mount the cord cleat at a safe height, take into account furniture or other objects upon which a child may climb. Then, after the use of the blind, simply wrap the excess cord around the cleat.

PRELUDE SHADES

	Page
Hardware Options	1
Size Standards	3
Hardware Option Availability	9
Hardware Upgrade Options.	11
 PRICE GRIDS	
Standard Rectangular - Cord Lock Cordless Lift & Lock	Price Group 1-6 13
Ovation Cellular Slider.	Price Group 7-8 18
Starburst Arches Quarter Rounds	Price Group 9-10 19
Sunset Movable Arches.	Price Group 11-12 20
Trapezoids and Octagons	Price Group 13-14 21
Skylight Shadings	Price Group 15-16 22
 HARDWARE	
Standard Cord Lock.	24
Cord Loop	26
Cordless Ultra	28
Cordless Lift & Lock.	30
7.4V Rechargeable Simplicity Motorization.	32
7.4V Rechargeable Motorized Top Down-Bottom Up	35
7.4V Rechargeable PowerTouch Motorization	37
7.4V EZ Charge Extension Wand	39
Simplicity Smart Controller	40
Ovation Cellular Slider.	41
Starburst Arches	43
Sunset Arches	44
Quarter Rounds	46
Trapezoids	47
Skylight Shading	49
 GENERAL INFORMATION	
Cleaning and Care.	51
Measuring	52
Making A Template	53
Child Safety	54



Midwest
Designer
Supply

1-888-523-2611

**Midwest Designer Supply, Inc.
N30W22377 Green Road Ste C
Waukesha, WI 53186
(262) 523-2600
Fax (262) 524-1007
www.midwestdesignersupply.com**

MDS - your one source for window fashions.